



MILLENNIAL
TOUCH SCREEN

MILLENNIAL
SMART

MILLENNIAL
BLACK MASK



M I L L E N N I A L











Cooking











IT - EN

Indice

Index

About Tecnoeka			Pag. 4
About Millennial			Pag. 6
Ogni codice ti racconta una storia Each code tells you a story			Pag. 8
Design			Pag. 10
Airflowlogic™			Pag. 12
Humilogic™			Pag. 14
Drylogic™			Pag. 16
Sistema di lavaggio Washing system			Pag. 18
Plus M I L L E N N I A L TOUCH SCREEN			Pag. 19
M I L L E N N I A L TOUCH SCREEN			Pag. 20
M I L L E N N I A L BLACK MASK			Pag. 22
M I L L E N N I A L SMART			Pag. 24
Cooking	Forni elettrici e gas Electric and gas ovens		Pag. 26
MKF 511	Forno combinato convezione vapore 5 teglie 1/1 GN Combi oven 5 trays 1/1 GN		Pag. 28
MKF 711	Forno combinato convezione vapore 7 teglie 1/1 GN Combi oven 7 trays 1/1 GN		Pag. 30
MKF 1111	Forno combinato convezione vapore 11 teglie 1/1 GN Combi oven 11 trays 1/1 GN		Pag. 32
MKF 2011	Forno combinato convezione vapore 20 teglie 1/1 GN Combi oven 20 trays 1/1 GN		Pag. 34
MKF 621	Forno combinato convezione vapore 6 teglie 2/1 GN Combi oven 6 trays 2/1 GN		Pag. 36
MKF 1021	Forno combinato convezione vapore 10 teglie 2/1 GN Combi oven 10 trays 2/1 GN		Pag. 38
MKF 623 C	Forno combinato convezione vapore 6 teglie 2/3 GN COMPATTO COMPACT combi oven 6 trays 2/3 GN		Pag. 40
MKF 611 C	Forno combinato convezione vapore 6 teglie 1/1 GN COMPATTO COMPACT combi oven 6 trays 1/1 GN		Pag. 42
MKF 1011 C	Forno combinato convezione vapore 10 teglie 1/1 GN COMPATTO COMPACT combi oven 10 trays 1/1 GN		Pag. 44

Mantenitori Holding cabinets	Mantenitori elettrici per forni Electric holding cabinets for ovens	⚡	Pag. 46
MKM 1211	Mantenitore elettrico per forni 5, 7 e 11 teglie BM e TS, comandato dal forno Electric holding cabinet for 5, 7 e 11 trays ovens BM e TS, controlled by the oven	⚡	Pag. 47
Cappe Condensation hoods	Cappe elettriche di aspirazione a condensazione per forni Electric condensation hood for ovens	⚡	Pag. 48
MKCC 5 S	Cappa elettrica di aspirazione a condensazione per forni 5 teglie S Electric condensation hood for 5 trays ovens S	⚡ 	Pag. 49
MKCC 5	Cappa elettrica di aspirazione a condensazione per forni 5 teglie BM e TS, comandata dal forno Electric condensation hood for 5 trays BM and TS ovens, controlled by the oven	⚡	Pag. 49
MKCC 711 S	Cappa elettrica di aspirazione a condensazione per forni 7 e 11 teglie S Electric condensation hood for 7 and 11 trays ovens S	⚡ 	Pag. 50
MKCC 711	Cappa elettrica di aspirazione a condensazione per forni 7 e 11 teglie BM e TS, comandata dal forno Electric condensation hood for 7 and 11 trays BM and TS ovens, controlled by the oven	⚡	Pag. 50
MKCC 1620 S	Cappa elettrica di aspirazione a condensazione per forni 16 e 20 teglie S Electric condensation hood for 16 and 20 trays ovens S	⚡ 	Pag. 51
MKCC 1620	Cappa elettrica di aspirazione a condensazione per forni 16 e 20 teglie BM e TS, comandata dal forno Electric condensation hood for 16 and 20 trays BM and TS ovens, controlled by the oven	⚡	Pag. 51
MKCC 610 S	Cappa elettrica di aspirazione a condensazione per forni 6 e 10 teglie S Electric condensation hood for 6 and 10 trays ovens S	⚡ 	Pag. 52
MKCC 610	Cappa elettrica di aspirazione a condensazione per forni 6 e 10 teglie BM e TS, comandata dal forno Electric condensation hood for 6 and 10 trays BM and TS ovens, controlled by the oven	⚡	Pag. 52
MKCC 623 C	Cappa elettrica di aspirazione a condensazione per forni 6 teglie 2/3 GN COMPATTI, comandata dal forno Electric condensation hood for 6 trays 2/3 GN COMPACT ovens, controlled by the oven	⚡	Pag. 53
MKCC 610 C	Cappa elettrica di aspirazione a condensazione per forni 6 e 10 teglie 1/1 GN COMPATTI, comandata dal forno Electric condensation hood for 6 and 10 trays 1/1 GN COMPACT ovens, controlled by the oven	⚡	Pag. 54
Tavoli e carrelli Tables and trolleys			Pag. 56
Complementi Optional			Pag. 58
Teglie e griglie Trays and grids			Pag. 62
Versatilità 1/1 GN 1/1 GN Modular design			Pag. 64
Versatilità 2/1 GN 2/1 GN Modular design			Pag. 67
Versatilità COMPATTI COMPACT Modular design			Pag. 68
Comparativo compatibilità Comparative of compatibility			Pag. 70

About Tecnoeka



Il futuro è iniziato nel 1978

Siamo nati nel 1978 per portare avanti idee forti e innovative, sulle quali abbiamo costruito giorno dopo giorno la nostra unicità. L'acciaio è la nostra materia prima.
L'elemento col quale creiamo macchine con un cuore e un'anima.
Perché dietro ogni singolo forno, c'è sempre un gruppo di persone.
Uomini e donne che uniscono la loro capacità e passione per sviluppare la soluzione più avanzata e raggiungere gli obiettivi più ambiziosi.
L'innovazione tecnologica è la nostra firma.
Immettiamo sul mercato solo le tecnologie più performanti grazie alle conoscenze ingegneristiche più avanzate.
Continuiamo a superarci costantemente creando forni professionali attraverso processi evoluti, responsabili ed efficienti.
Il design italiano è il nostro orgoglio.
Crediamo nella creatività, qualità ed affidabilità italiana.
Coniughiamo la ricerca estetica con la funzionalità, nei nostri prodotti così come nel nostro headquarter, costruito e organizzato attraverso concetti di architettura, tecnologia e rispetto per l'ambiente.
La soddisfazione dei professionisti della ristorazione è il nostro obiettivo, perseguito sempre con maggiore impegno e con grande soddisfazione.
Un'attitudine che ci permette di dar lustro all'abilità ingegneristica italiana in più di 100 paesi nel mondo, varcando ogni giorno nuovi confini grazie al nostro nome, alla nostra storia e alla nostra idea di ristorazione.

The future began in 1978

We were born in 1978 to pursue strong and innovative ideas, on which we have built our day-to-day uniqueness. Steel is our raw material.
The element with which we create machines with a heart and soul.
Because behind every single oven there is always a group of people.
Men and women who combine their ability and passion to always develop the most advanced solution and achieve the most ambitious goals.
Technological innovation is our signature.
We only introduce the most efficient technologies on the market, thanks to the most advanced specialist knowledge. We continue to surpass ourselves by creating professional ovens through evolved, responsible and efficient processes.
Italian design is our pride.
We believe in Italian creativity, quality and reliability.
We combine aesthetic research with functionality, in our products as well as in our headquarters, built and organised through concepts of architecture, technology and respect for the environment.
Our goal lies in the satisfaction of catering professionals. Always sought for with utmost commitment and great gratification.
An attitude that allows us to give distinction to Italian engineering skills in more than 100 countries around the world.
Every day new frontiers are crossed thanks to our name, our history and our idea of catering.

About Millennial



Ci sono sfide che ti spingono oltre i limiti di ciò che è conosciuto,
e superare il limite a volte può fare paura.
Non a noi.

Il coraggio e la passione sono la firma che mettiamo dentro ad ogni progetto.
Una firma scolpita a chiare lettere sull'acciaio della linea MILLENNIAL.
Siamo orgogliosi di presentarvi la nuova generazione di forni progettata per soddisfare e stupire il professionista della ristorazione durante il suo lavoro quotidiano.
Con MILLENNIAL la qualità costruttiva incontra il futuro della ristorazione per dare alla luce qualcosa che non si era mai visto prima.

MILLENNIAL
è **tecnologia**, è **design**, è **semplicità** di utilizzo.

MILLENNIAL è la differenza tra chi parla di qualità e chi conosce il significato profondo di questa parola.
La differenza tra chi percorre sempre le stesse strade e chi, come noi, porta l'innovazione nelle cucine di tutto il mondo attraverso il coraggio delle idee.

There are challenges that push you beyond the limits of what is known.
And overcoming the limit can sometimes be scary.
Not for us.

Courage and passion are our signature in each project.
A signature sculpted in clear letters on the steel of the MILLENNIAL line.
We are proud to introduce you to the new generation of ovens designed to satisfy and amaze catering professionals during their daily work.
With MILLENNIAL the constructive quality meets the future of catering to bring something to light that has never been seen before.

MILLENNIAL
is **technology**, it's **design** and it's **easy** to use.

MILLENNIAL is the difference between those who speak of quality and those who know the deep meaning of this word.
The difference between those who always walk the same streets and those who like us, bring innovation to kitchens around the world through courageous ideas.

Ogni codice
ti racconta
una storia
Each code
tells you
a story

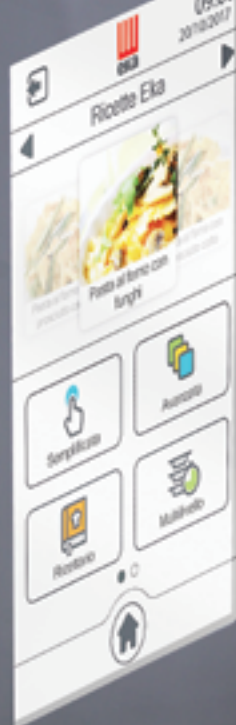

Ogni codice ti racconta una storia

Each code tells you a story

MKF 6 11 V CTS P

Famiglia

Family
E Evolution
M Millennial

Marchio

Brand
K Eka

Prodotto

Product
F forno/oven
FD forno deck/deck oven
C cucina/cooker
P piano di cottura da appoggio
counterop cooking plan
KC cappa a condensazione/condensation hood
LM lievitatore e mantentore/proofer and holding cabinet
L lievitatore/proofer
M mantentore/ holding cabinet
CR carrello/trolley
T tavolo/table
TS tavolo con supporti/table with supports
TR tavolo con ruote/table with wheels
TRS tavolo con ruote e supporti/table with wheels and supports
TSD tavolo con supporti deck/table with supports deck
TPL tavolo polli/closet
S kit sovrapposizione forni/kit for overlapping ovens
ST kit sovrapposizione tavoli/kit overlapping tables
SST kit sovrapposizione forni con supporti teglie
kit for overlapping ovens with trays supports
SCMU sonda al cuore multipunto/multi-point core probe
SCMO sonda al cuore monopunto/single-point core probe
SCSV sonda al cuore sottovuoto/vacuum cooking core probe
SSC/A supporto sonda al cuore/support for core probe
AF affumicatore/smoker
CG concentratore grasso/fat concentrator
FCA filtro carboni attivi/activated carbon filter
RCA ricarica carboni attivi/activated carbon
BZ buzzer
WT sistema di lavaggio automatico/automatic washing system
DET detergente e brillantante LT. 10/detergent and rinse aid LT. 10
DETS detergente e brillantante LT. 5/detergent and rinse aid LT. 5
KR kit ruote/set of whells
KD kit doccia/spray kit
KAF addolcitore LT. 8/water softener LT.8
TA testata di connessione cartuccia filtrante
per trattamento acqua potabile/filter head for water optimisation
CA cartuccia filtrante per trattamento acqua potabile
filter for water optimisation
KPI kit prima installazione TS/first installation kit TS
KPIC kit prima installazione TS (compact)
first installation kit (compact)
KPI-BMS kit prima installazione BM e S/first installation kit BM and S
KPIC-BM kit prima installazione BM (compact)
first installation kit BM (compact)
CKIT kit cappa Millennial BM e TS
Millennial condensation hood kit BM e TS
CSKIT kit cappa Millennial S/Millennial condensation hood kit S

Numero teglie

Number of trays

3 tre teglie/three trays
4 quattro teglie/four trays
5 cinque teglie/five trays
6 sei teglie/six trays
7 sette teglie/seven trays
10 dieci teglie/ten trays
11 undici teglie/eleven trays
12 dodici teglie/twelve trays
16 sedici teglie/sixteen trays
20 venti teglie/twenty trays
1T uno teglia deck/one tray deck
2T due teglie deck/two trays deck

Caratteristiche Linea

Line Features
P pratico/practical

Linea

Line
S smart
BM black mask
TS touch screen

Linea forno

Oven line
C compact
(larghezza 500 mm)
(width 500 mm)

Caratteristiche Features

D double
(per sovrapposizione forni)
(for overlapping ovens)
V boiler
G gas
2 con 2 motori
with 2 motors
U umidificazione a pulsante
humidification by a button
UD vapore diretto
direct steam
.3 aumento di potenza
power increasing
GRILL resistenza grill
grill heating element
M multifunzione
multifunction
AL apertura laterale
side opening
R ruote
wheels
IX acciaio
stainless steel

Tipologia di teglia

Tray dimension
11 1/1 GN
12 1/2 GN (325 x 265 mm)
21 2/1 GN
23 2/3 GN (354 x 325 mm)
23 429 x 345 mm
43 480 x 340 mm
64 600 x 400 mm

Dimensioni esterne

External dimensions
96 900 x 600 mm
(cucine/cookers)

Design



Vetro interno porta termoriflettente per ridurre i consumi energetici, apribile e facilmente pulibile

Heat-reflecting internal glass to reduce energy consumption, easy to clean thanks to the unlock system

Protezione contro l'acqua IPX 4, IPX5 (forni elettrici) e IPX3, IPX4 (forni a gas)

IPX4, IPX5 (electric ovens) and IPX3, IPX4 (gas ovens) waterproof

Maniglia con chiusura a croce
Handle with cross closing

Camera di cottura in acciaio AISI 304 10/10 con fondo camera stampato e bordi completamente arrotondati

Cooking Chamber in Stainless Steel AISI304 10/10mm, with moulded bottom and fully rounded edges

Piedini regolabili
Adjustable feet



Porta reversibile con cerniera a scomparsa

Reversible door with concealed hinge

Supporti laterali in lamiera progettati per una migliore uniformità di cottura e rimovibili per facilitare la pulizia

Sheet metal made trays supports designed for a better uniformity of cooking and removable for a better cleaning

Touch screen di serie su forni MILLENNIAL TS standard on MILLENNIAL TS

Push-button di serie su forni MILLENNIAL TS standard on MILLENNIAL TS

Innovativo sistema di raffreddamento, che garantisce il funzionamento anche in spazi ristretti, di serie su forni MILLENNIAL TS elettrici

Innovative cooling system, that works perfectly even in narrow spaces, standard on electric ovens MILLENNIAL TS

Blocco porta a 60°, 90°, 120° e 180° di apertura
The opening door system can be locked at 60, 90, 120 and 180 degrees



MODELLO DEPOSITATO
DESIGN APPLICATION

Design minimal ed elegante per un forno professionale che aggrega funzionalità ed innovazioni tecnologiche che vanno sempre nella direzione della miglior qualità del lavoro nelle cucine.

Minimal and elegant design for a professional oven that combines functionality and technological innovations, aspects that always go towards the best quality of kitchen works.

Airflowlogic™





Airflowlogic™ by Tecnoeka è l'innovazione tecnologica brevettata che, grazie ad un carter completamente ridisegnato e ad un profondo studio del ricircolo dell'aria all'interno del forno, permette il raggiungimento di risultati ottimali nell'uniformità di cottura in tutte le aree del forno. L'uniformità grazie a Airflowlogic™ oggi diventa una garanzia per tutti coloro che scelgono l'eccellenza, per tutti coloro che scelgono Millennial.

Canale di aspirazione
Inlet ductwork

**Nuova geometria
che unisce estetica
e funzionalità**
New geometry which
combines aesthetics and
functionality

**Uniformità di
ventilazione all'interno
della camera di cottura**
Uniform airflow into
the cooking chamber

**Configurazione sezioni
di aspirazione sia a passo
che a geometria variabile
per ottimizzare i flussi
d'aria nella camera**
Different sizes of inlet
ductworks in order
to optimize the air intake
into the cooking chamber

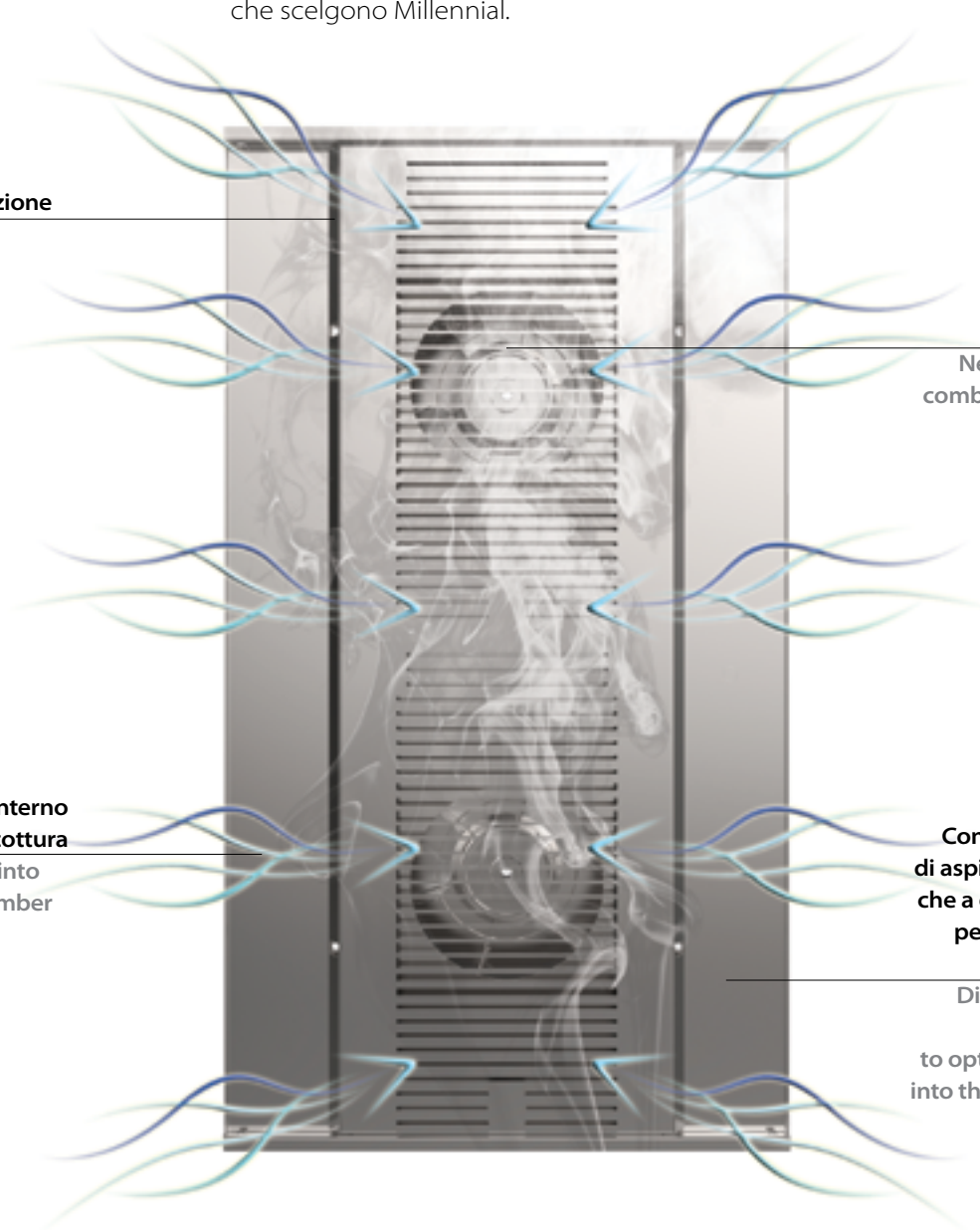

Airflowlogic™ by Tecnoeka is the patented technological innovation that, thanks to a completely redesigned fan guard and a deep study of the air recirculation inside the oven, allows the achievement of optimal cooking uniformity in all the areas of the oven. Thanks to Airflowlogic™, uniformity becomes today a guarantee for all those who choose excellence and all those who choose Millennial.

Humilogic™





Tecnoeka presenta Humilogic™, un nuovo sistema brevettato con l'inserimento di acqua direttamente nella parte posteriore della ventola che garantisce il raggiungimento di alti livelli di umidità in camera di cottura per delle cotture a vapore di qualità e una consistente riduzione dei consumi. Humilogic™, dove il vapore incontra il sapore, mascherandosi nelle forme del cibo, esaltandone la fragranza degli aromi. Humilogic™, l'eccellenza in cucina, per tutti coloro che scelgono Millennial.

Fori per la fuoriuscita dell'acqua

Water output nozzles

Scomposizione in micro particelle d'acqua tramite l'impatto con le pale della ventola

Water contact with in-movement fan blades generates drops nebulization

Vapore generato dal contatto delle particelle d'acqua con il calore della resistenza

Steam generated by the contact of the water particles with the heating elements surface

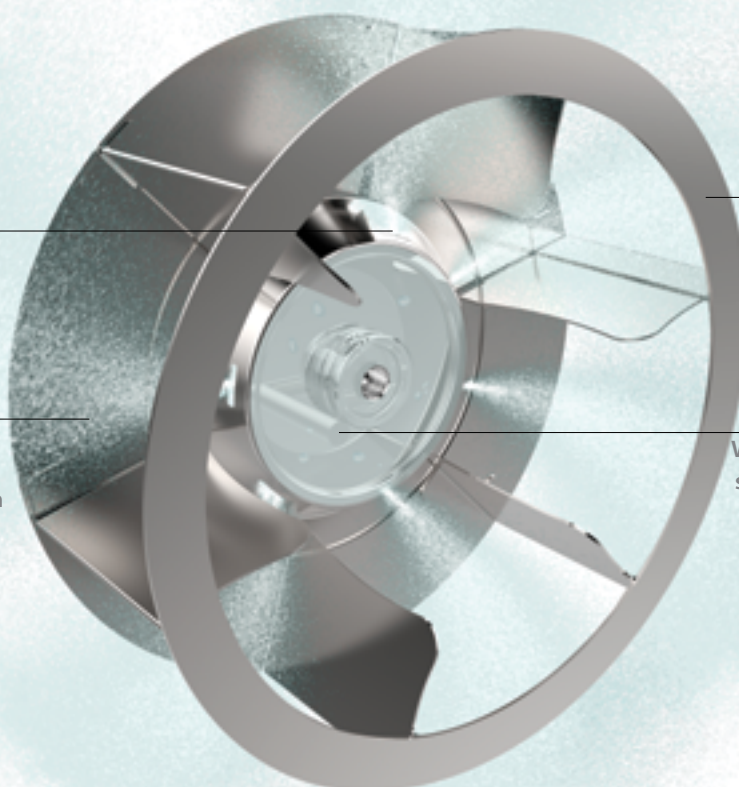

Movimento centrifugo della ventola che permette una distribuzione uniforme dell'acqua

The centrifugal movement of the fan allows the uniform water micro-particles distribution

Introduzione dell'acqua per l'umidificazione dalla parte posteriore della ventola

Water is introduced to the rear side of the fan to humidify the cooking chamber

Tecnoeka presents Humilogic™, a new-patented system with humidification on the rear that ensures high levels of moisture in the cooking chamber for quality steam cooking and a significant reduction of consumption. Humilogic™, where steam meets flavour and blends in the food thus exalting the fragrance of the aromas. Humilogic™, "Excellence in Kitchen" for all those who choose Millennial.

Drylogic™





Con il brevettato sistema di essiccazione rapida della camera di cottura Drylogic™ by Tecnoeka si ottengono cotture eccelse. La tecnologia Drylogic™ opera tramite l'introduzione nel forno di aria prelevata dall'ambiente esterno al fine di ridurre l'umidità presente all'interno della camera di cottura. Attraverso il controllo di specifici parametri predefiniti la linea Millennial ha il pieno controllo nella gestione dell'umidità.

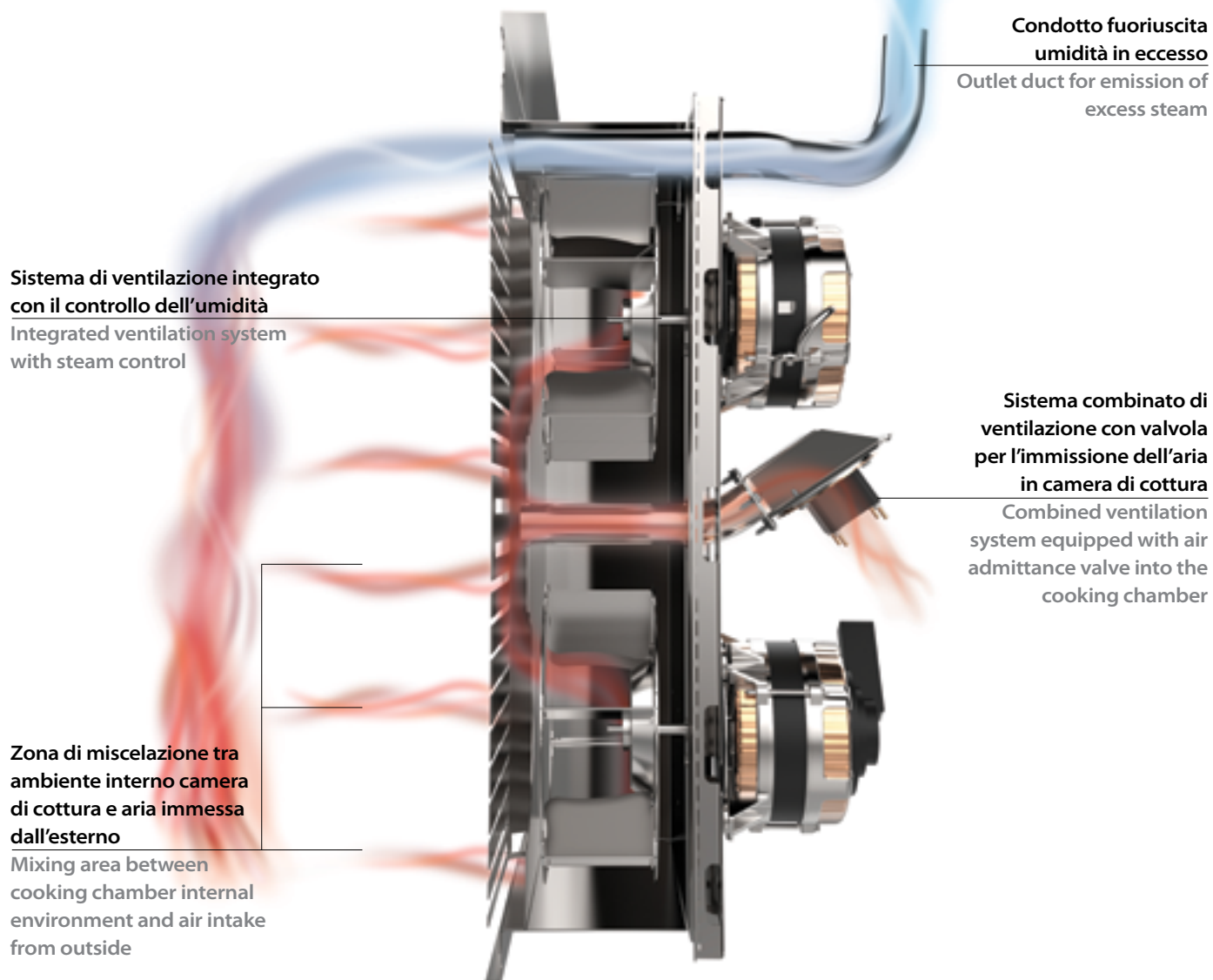

Drylogic™ by Tecnoeka. This new-patented quick-drying system in the cooking chamber allows you to reach excellent cooking. Drylogic™ technological system introduces into the oven air extracted from outside, thus reducing the moisture inside the cooking chamber. Through control of specific predefined parameters, the Millennial line has full control over managing moisture in the cooking chamber.

Sistema di lavaggio

Washing system

4

Sistemi di lavaggio
L1 ECO, L2 NORMALE,
L3 INTENSIVO, R RISCIAQUO
Washing systems
L1 ECO, L2 NORMAL,
L3 INTENSIVE, R RINSE



- 30%

Consumi di acqua
Water consumption

Detergente e brillantante uniti
in un unico prodotto
Detergent and rinse aid combined
in a single product

**Nuovo sistema di lavaggio di serie,
minor ingombro, minor consumi e più efficienza**
New washing system included,
less bulky, less consumptions and more efficiency

Plus

MILLENNIAL

TOUCH SCREEN



30-270 °C

Forni elettrici - Electric ovens

30-260 °C

Forni a gas - Gas ovens

Gestione della temperatura

Temperature management

5

Regolazioni della velocità di ventilazione

Speed fan regulations

Aggiornamento del firmware del forno

Oven firmware update

Gestione programma HACCP

HACCP data management

Software per gestione dell'umidità

Moisture Management Software

Gestione cotture sottovuoto e DELTA T

Vacuum cooking management and DELTA T

Cottura semistatica

Semi-static cooking mode

Aggiornamento della documentazione tecnica e dei manuali presenti nel forno

Updating of technical documentation and user manuals in the oven

10

Fasi per ogni ciclo di cottura

Steps for each cooking cycle

Aggiornamento dei ricettari

Recipes update



Modalità di cottura multilivello che permette di cucinare assieme pietanze con lo stesso grado di umidificazione e di temperatura, ma diverso tempo di cottura

Multilevel cooking mode allows you to cook at the same time different kind of foods that require the same climax conditions with different cooking times

**Gestione a 360° delle funzioni,
forno collegabile in rete attraverso connessione Wi-Fi**

360 ° management of functions,
oven connectable via Wi-Fi connection

MILLENNIAL TOUCH SCREEN



- Pannello TFT 7" capacitivo a colori 800x480 touch screen
 - Manopola con funzione scroll e push
- Tre brevetti: **Airflowlogic™**, **Humilogic™**, **Drylogic™**
 - Lavaggio automatico integrato
 - Sonda al cuore multipunto di serie
 - Temperatura forni elettrici da 30 a 270 °C
forni gas da 30 a 260 °C
 - 10 fasi di cottura programmabili
 - Vapore diretto con regolazione automatica attraverso selettore touch screen (10 steps)
 - Preriscaldamento
 - Mantenimento
 - Raffreddamento rapido
 - Camera di cottura in AISI 304
 - Vetro porta ispezionabile
 - Protezione acqua: IPX3, IPX4, IPX5
 - Presa USB
 - Sistema per HACCP
- Vaschetta raccogli condensa con scarico su porta
 - Cerniera con bloccoporta per aperture regolate a 60°, 90°, 120°, 180°
 - Partenza ritardata programmabile fino a 24 h
- Possibilità di comandare cappa, lievitatore e mantenedor
 - Gestione rapida delle ricette di utilizzo più frequenti
 - Ricette programmabili: 500
 - 42 lingue
 - Piedini regolabili
- TFT 7" capacitive 800x480 color touch screen panel
 - Knob with scroll and push function
- Three patents: **Airflowlogic™**, **Humilogic™**, **Drylogic™**
 - Automatic washing system integrated
 - Multipoint core probe
 - Temperature of electric ovens from 30 to 270 °C
gas ovens from 30 to 260 °C
 - 10 programmable cooking phases
 - Direct steam controlled by touch screen (10 steps)
 - Preheating
 - Holding
 - Cooldown
 - Cooking chamber in AISI 304
 - Inspectionable door glass
 - Protection against water: IPX3, IPX4, IPX5
 - USB socket
 - HACCP system
 - Condensate collection bowl, with drain on door
 - Hinge with door locking for openings adjusted at 60°, 90°, 120°, 180°
 - Delayed start programmable up to 24 h
- Possibility to drive condensation hood and holding cabinet
 - Favorite recipes quick settings
 - Programmable recipes: 500
 - 42 languages
 - Adjustable feet

Pannello TOUCH SCREEN

TOUCH SCREEN panel

- 1 Ora e data - Time and date
- 2 Lista ricette - Recipes list
- 3 Cottura semplificata - Simplified cooking
- 4 Cottura avanzata - Expert cooking
- 5 Ricettario - Recipe book
- 6 Cottura multilivello - Multi-level cooking
- 7 Home
- 8 Accessori - Accessories
- 9 Raffreddamento rapido - Cooldown
- 10 Impostazioni - Settings
- 11 Servizio tecnico - After sales service



MILLENNIAL

BLACK MASK



- Pannello 7" black mask electronic control
 - Due brevetti: **Airflowlogic™, Humilogic™**
 - Semplicità d' utilizzo
 - Temperatura forni elettrici da 30 a 270 °C
forni gas da 30 a 260 °C
 - 10 fasi di cottura programmabili
 - Vapore diretto con regolazione attraverso
selettore pannello black mask (10 steps)
 - Preriscaldamento
 - Mantenimento
 - Raffreddamento rapido
 - Camera di cottura in AISI 304
 - Vetro porta ispezionabile
 - Protezione acqua: IPX3, IPX4
 - Presa USB
 - Sistema per HACCP
 - Predisposizione sonda al cuore
 - Predisposizione al lavaggio automatico
 - Vaschetta raccogli condensa con scarico su porta
 - Cerniera con bloccoporta per aperture
regolate a 60°, 90°, 120°, 180°
 - Partenza ritardata programmabile fino a 24 h
 - Possibilità di comandare cappa, lievitatore e manteneritore
 - Ricette programmabili: 100
 - Piedini regolabili
-
- 7" Black mask electronic control panel
 - Two patents: Airflowlogic™, Humilogic™
 - Easy to use
 - Temperature of electric ovens from 30 to 270 °C
gas ovens from 30 to 260 °C
 - 10 programmable cooking phases
 - Direct steam controlled
by black mask panel (10 steps)
 - Preheating
 - Holding
 - Cooldown
 - Cooking chamber in AISI 304
 - Inspectionable door glass
 - Protection against water: IPX3, IPX4
 - USB socket
 - HACCP system
 - Core probe predisposition
 - Automatic washing system predisposition
 - Condensate collection bowl, with drain on door
 - Hinge with door locking for openings
adjusted at 60°, 90°, 120°, 180°
 - Delayed start programmable up to 24 h
 - Possibility to command the holding cabinet
 - Programmable recipes: 100
 - Adjustable feet

Pannello **BLACK MASK**

BLACK MASK panel

- 1 Preriscaldamento - Preheating
- 2 Mantenimento - Holding
- 3 Raffreddamento rapido - Cooldown
- 4 Sistema di lavaggio - Washing system
- 5 H.A.C.C.P.
- 6 Lievitatore - Proofer
- 7 Manteneritore - Holding cabinet
- 8 Allarme cappa - Condensation hood alarm
- 9 Più - Plus
- 10 Meno - Less
- 11 ON/OFF
- 12 Start/Stop

- 13 Cestino - Delete
- 14 Partenza ritardata - Delayed start
- 15 Numero ricetta - Recipe number
- 16 Menù Eka - Eka's recipes
- 17 Menù Chef - Chef's recipes
- 18 Velocità ventole - Speed fans
- 19 Funzione ventola: normale, semistatica, 1/2 potenza
Fan function: normal, semi-static, 1/2 power
- 20 Sonda al cuore - Core probe
- 21 ΔT
- 22 Temperatura sonda - Core temperature
- 23 Vapore - Steam
- 24 Temperatura - Temperature
- 25 USB
- 26 Tempo di cottura - Time of cooking
- 27 Fase di cottura - Cooking step
- 28 Ora e data - Time and date

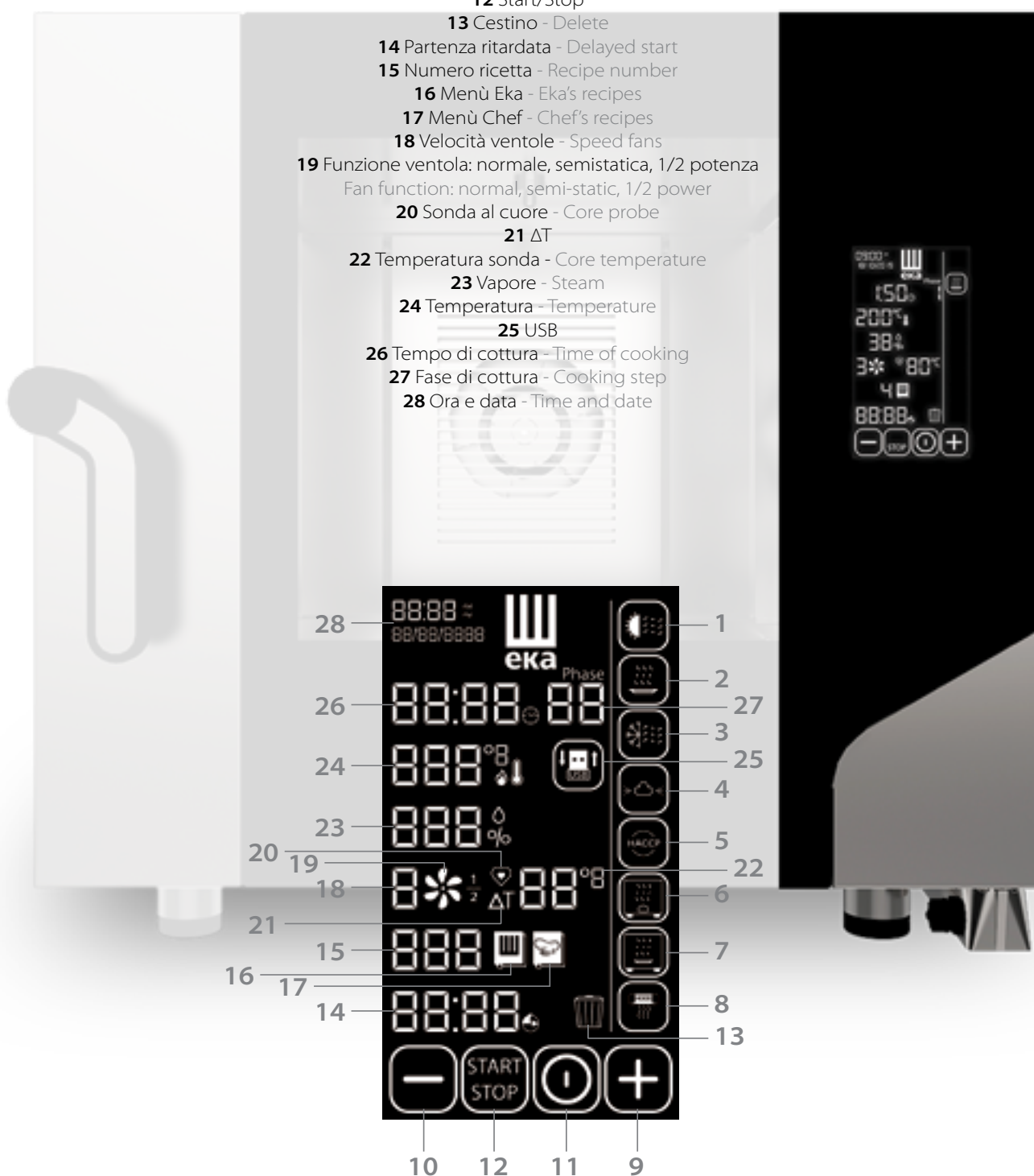

MILLENNIAL

SMART



- Pannello elettromeccanico
- Semplicità d' utilizzo
- Timer per cottura da 10 a 120 minuti / infinito
- Temperatura forni elettrici da 100 a 270 °C
- forni gas da 100 a 260 °C
- Vapore diretto con regolazione attraverso selettore a manopola (5 steps)
- Camera di cottura in AISI 304
- Vetro porta ispezionabile
- Protezione acqua: IPX3, IPX4
- Predisposizione al lavaggio manuale
- Certificazione CB
- Vaschetta raccogli condensa con scarico su porta
- Cerniera con bloccoporta per aperture regolate a 60°, 90°, 120°, 180°
- Piedini regolabili

- Electromechanic panel
- Easy to use
- Timer for cooking from 10 to 120 minutes / infinity
- Temperature of electric ovens from 100 to 270 °C
- gas ovens from 100 to 260 °C
- Direct steam controlled by knob (5 steps)
- Cooking chamber in AISI 304
- Inspectable door glass
- Protection against water: IPX3, IPX4
- Manual washing predisposition
- CB certification
- Condensate collection bowl, with drain on door
- Hinge with door locking for openings adjusted at 60°, 90°, 120°, 180°
- Adjustable feet

Pannello **SMART**

SMART panel

- 1 Tempo - Time
- 2 Temperatura - Temperature
- 3 Vapore - Steam







M I L L E N N I A L
Cooking



MKF 511

Forno combinato convezione
vapore 5 teglie 1/1 GN
Combi oven 5 trays 1/1 GN

SMART

MKF 511 S



Elettrico
Electricity ⚡

BLACK MASK

MKF 511 BM



Elettrico
Electricity ⚡

Alimentazione
Power

Numero pasti
Number of meals

75 - 100

75 - 100

Numero teglie
Number of trays

5

5

Dimensioni teglia
Tray dimension

1/1 GN

1/1 GN

Passo guide
Rack rails distance

68 mm

68 mm

Temperatura
Temperature

100 - 270 °C

30 - 270 °C

Potenza - Portata termica
Power supply - Thermal supply

7,8 kW

7,8 kW

Voltaggio
Voltage

AC 380/400 3N

AC 380/400 3N

Frequenza
Frequency

50 Hz (60 su richiesta)
50 Hz (60 on demand)

50/60 Hz

Pannello comandi
Control panel

Elettromeccanico
Electromechanic

Black mask
electronic control

N. Programmi
N. programs

/

100

Lavaggio automatico
Automatic washing

/

Su richiesta
On demand

Sonda al cuore
Core probe

/

Su richiesta
On demand

Dimensioni (LxPxH)
Dimensions (WxDxH)

730 x 855 x 700 mm

730 x 849 x 700 mm

Peso
Weight

78,4 kg

78,4 kg

Generatore di vapore
Boiler

/

/

TOUCH SCREEN
SMART
BLACK MASK
TOUCH SCREEN
MKF 511 TS

 Elettrico
Electricity ⚡

MKF 511 G S

Gas 🔥

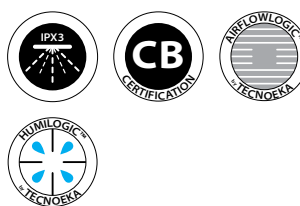
MKF 511 G BM

Gas 🔥

MKF 511 GTS

Gas 🔥

75 - 100	75 - 100	75 - 100	75 - 100
5	5	5	5
1/1 GN	1/1 GN	1/1 GN	1/1 GN
68 mm	68 mm	68 mm	68 mm
30 - 270 °C	100 - 260 °C	30 - 260 °C	30 - 260 °C
7,8 kW	9,3 kW	9,3 kW	9,3 kW
AC 380/400 3N	AC 220/230	AC 220/230	AC 220/230
50/60 Hz	50 Hz (60 su richiesta) 50 Hz (60 on demand)	50/60 Hz	50/60 Hz
Touch screen	Elettromeccanico Electromechanic	Black mask electronic control	Touch screen
500	/	100	500
Incluso Included	/	Su richiesta On demand	Incluso Included
Inclusa MKSCMU/A Included MKSCMU/A	/	Su richiesta On demand	Inclusa MKSCMU/A Included MKSCMU/A
730 x 849 x 700 mm	730 x 855 x 801 mm	730 x 849 x 801 mm	730 x 850 x 800 mm
78,4 kg	89 kg	89 kg	89 kg
/	/	/	/

MKF 711

Forno combinato convezione
vapore 7 teglie 1/1 GN
Combi oven 7 trays 1/1 GN

SMART

MKF 711 S



BLACK MASK

MKF 711 BM



TOUCH SCREEN

MKF 711 TS



Alimentazione Power	Elettrico Electricity ⚡	Elettrico Electricity ⚡	Elettrico Electricity ⚡
Numero pasti Number of meals	105 - 140	105 - 140	105 - 140
Numero teglie Number of trays	7	7	7
Dimensioni teglia Tray dimension	1/1 GN	1/1 GN	1/1 GN
Passo guide Rack rails distance	68 mm	68 mm	68 mm
Temperatura Temperature	100 - 270 °C	30 - 270 °C	30 - 270 °C
Potenza - Portata termica Power supp.-Thermal supp.	10,4 kW	10,4 kW	11,4 kW
Voltaggio Voltage	AC 380/400 3N	AC 380/400 3N	AC 380/400 3N
Frequenza Frequency	50 Hz (60 su richiesta) 50 Hz (60 on demand)	50/60 Hz	50/60 Hz
Pannello comandi Control panel	Elettromeccanico Electromechanic	Black mask electronic control	Touch screen
N. Programmi N. programs	/	100	500
Lavaggio automatico Automatic washing	/	Su richiesta On demand	Incluso Included
Sonda al cuore Core probe	/	Su richiesta On demand	Inclusa MKSCMU/A Included MKSCMU/A
Dimensioni (LxPxH) Dimensions (WxDxH)	730 x 855 x 850 mm	730 x 849 x 850 mm	730 x 849 x 850 mm
Peso Weight	96 kg	96 kg	96 kg
Generatore di vapore Boiler	/	/	/

TOUCH SCREEN
SMART
BLACK MASK
TOUCH SCREEN
MKF 711 V TS

 Elettrico
Electricity ⚡

MKF 711 G S

Gas 🔥

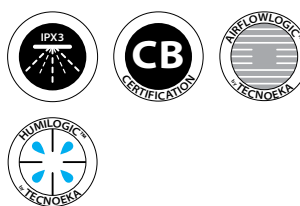
MKF 711 G BM

Gas 🔥

MKF 711 G TS

Gas 🔥

105 - 140	105 - 140	105 - 140	105 - 140
7	7	7	7
1/1 GN	1/1 GN	1/1 GN	1/1 GN
68 mm	68 mm	68 mm	68 mm
30 - 270 °C	100 - 260 °C	30 - 260 °C	30 - 260 °C
15 kW	13,5 kW	13,5 kW	13,5 kW
AC 380/400 3N	AC 220/230	AC 220/230	AC 220/230
50/60 Hz	50 Hz (60 su richiesta) 50 Hz (60 on demand)	50/60 Hz	50/60 Hz
Touch screen	Elettromeccanico Electromechanic	Black mask electronic control	Touch screen
500	/	100	500
Incluso Included	/	Su richiesta On demand	Incluso Included
Inclusa MKSCMU/A Included MKSCMU/A	/	Su richiesta On demand	Inclusa MKSCMU/A Included MKSCMU/A
730 x 849 x 850 mm	730 x 855 x 951 mm	730 x 849 x 951 mm	730 x 850 x 950 mm
102 kg	108,5 kg	108,5 kg	108,5 kg
Incluso Included Ⓢ	/	/	/

MKF 1111

Forno combinato convezione
vapore 11 teglie 1/1 GN
Combi oven 11 trays 1/1 GN

SMART

MKF 1111 S



BLACK MASK

MKF 1111 BM



TOUCH SCREEN

MKF 1111 TS



Alimentazione Power	Elettrico Electricity ⚡	Elettrico Electricity ⚡	Elettrico Electricity ⚡
Numero pasti Number of meals	165 - 220	165 - 220	165 - 220
Numero teglie Number of trays	11	11	11
Dimensioni teglia Tray dimension	1/1 GN	1/1 GN	1/1 GN
Passo guide Rack rails distance	68 mm	68 mm	68 mm
Temperatura Temperature	100 - 270 °C	30 - 270 °C	30 - 270 °C
Potenza - Portata termica Power supp.-Thermal supp.	15,4 kW	15,4 kW	15,4 kW
Voltaggio Voltage	AC 380/400 3N	AC 380/400 3N	AC 380/400 3N
Frequenza Frequency	50 Hz (60 su richiesta) 50 Hz (60 on demand)	50/60 Hz	50/60 Hz
Pannello comandi Control panel	Elettromeccanico Electromechanic	Black mask electronic control	Touch screen
N. Programmi N. programs	/	100	500
Lavaggio automatico Automatic washing	/	Su richiesta On demand	Incluso Included
Sonda al cuore Core probe	/	Su richiesta On demand	Inclusa MKSCMU/A Included MKSCMU/A
Dimensioni (LxPxH) Dimensions (WxDxH)	730 x 855 x 1130 mm	730 x 849 x 1130 mm	730 x 849 x 1130 mm
Peso Weight	113,8 kg	113,8 kg	113,8 kg
Generatore di vapore Boiler	/	/	/

TOUCH SCREEN
SMART
BLACK MASK
TOUCH SCREEN
MKF 1111 VTS

 Elettrico
Electricity ⚡

MKF 1111 GS

Gas 🔥

MKF 1111 G BM

Gas 🔥

MKF 1111 GTS

Gas 🔥

165 - 220	165 - 220	165 - 220	165 - 220
11	11	11	11
1/1 GN	1/1 GN	1/1 GN	1/1 GN
68 mm	68 mm	68 mm	68 mm
30 - 270 °C	100 - 260 °C	30 - 260 °C	30 - 260 °C
19 kW	17,5 kW	17,5 kW	17,5 kW
AC 380/400 3N	AC 220/230	AC 220/230	AC 220/230
50/60 Hz	50 Hz (60 su richiesta) 50 Hz (60 on demand)	50/60 Hz	50/60 Hz
Touch screen	Elettromeccanico Electromechanic	Black mask electronic control	Touch screen
500	/	100	500
Incluso Included	/	Su richiesta On demand	Incluso Included
Inclusa MKSCMU/A Included MKSCMU/A	/	Su richiesta On demand	Inclusa MKSCMU/A Included MKSCMU/A
730 x 849 x 1130 mm	730 x 855 x 1231 mm	730 x 849 x 1231 mm	730 x 850 x 1230 mm
141 kg	141 kg	141 kg	141 kg
Incluso Included Ⓜ	/	/	/

MKF 2011

Forno combinato convezione
vapore 20 teglie 1/1 GN
Combi oven 20 trays 1/1 GN

SMART

MKF 2011 S



Elettrico
Electricity ⚡

Alimentazione Power	
Numero pasti Number of meals	300 - 400
Numero teglie Number of trays	20
Dimensioni teglia Tray dimension	1/1 GN
Passo guide Rack rails distance	66 mm
Temperatura Temperature	100 - 270 °C
Potenza - Portata termica Power supply - Thermal supply	31 kW
Voltaggio Voltage	AC 380/400 3N
Frequenza Frequency	50 Hz (60 su richiesta) 50 Hz (60 on demand)
Pannello comandi Control panel	Elettromeccanico Electromechanic
N. Programmi N. programs	/
Lavaggio automatico Automatic washing	/
Sonda al cuore Core probe	/
Dimensioni (LxPxH) Dimensions (WxDxH)	930 x 1041 x 1900 mm
Peso Weight	247,2 kg
Generatore di vapore Boiler	/

BLACK MASK
TOUCH SCREEN
BLACK MASK
TOUCH SCREEN
MKF 2011 BM
MKF 2011 TS
MKF 2011 G BM
MKF 2011 G TS

 Elettrico
Electricity ⚡

 Elettrico
Electricity ⚡

Gas 🔥

Gas 🔥

MKF 621

Forno combinato convezione
vapore 6 teglie 2/1 GN
Combi oven 6 trays 2/1 GN

Alimentazione

Power

Numero pasti

Number of meals

Numero teglie

Number of trays

Dimensioni teglia

Tray dimension

Passo guide

Rack rails distance

Temperatura

Temperature

Potenza - Portata termica

Power supply - Thermal supply

Voltaggio

Voltage

Frequenza

Frequency

Pannello comandi

Control panel

N. Programmi

N. programs

Lavaggio automatico

Automatic washing

Sonda al cuore

Core probe

Dimensioni (LxPxH)

Dimensions (WxDxH)

Peso

Weight

Generatore di vapore

Boiler

SMART
BLACK MASK
TOUCH SCREEN
TOUCH SCREEN
MKF 621 S

 Elettrico
 Electricity

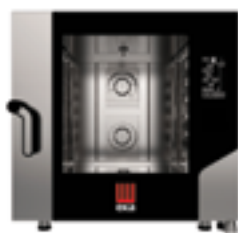
MKF 621 BM

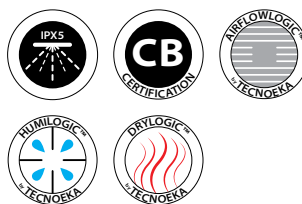
 Elettrico
 Electricity

MKF 621 TS

 Elettrico
 Electricity

MKF 621 G TS

Gas

180 - 270	180 - 270	180 - 270	180 - 270
6	6	6	6
2/1 GN	2/1 GN	2/1 GN	2/1 GN
80 mm	80 mm	80 mm	80 mm
100 - 270 °C	30 - 270 °C	30 - 270 °C	30 - 260 °C
18,4 kW	18,4 kW	18,4 kW	13,5 kW
AC 380/400 3N	AC 380/400 3N	AC 380/400 3N	AC 220/230
50 Hz (60 su richiesta) 50 Hz (60 on demand)	50/60 Hz	50/60 Hz	50/60 Hz
Elettromeccanico Electromechanic	Black mask electronic control	Touch screen	Touch screen
/	100	500	500
/	Su richiesta On demand	Incluso Included	Incluso Included
/	Su richiesta On demand	Inclusa MKSCMU/A Included MKSCMU/A	Inclusa MKSCMU/A Included MKSCMU/A
850 x 1041 x 850 mm	850 x 1035 x 850 mm	850 x 1035 x 850 mm	850 x 1035 x 950 mm
108,2 kg	108,2 kg	108,2 kg	120 kg
/	/	/	/

MKF 1021

Forno combinato convezione
vapore 10 teglie 2/1 GN
Combi oven 10 trays 2/1 GN

Alimentazione
Power

Numero pasti
Number of meals

Numero teglie
Number of trays

Dimensioni teglia
Tray dimension

Passo guide
Rack rails distance

Temperatura
Temperature

Potenza - Portata termica
Power supply - Thermal supply

Voltaggio
Voltage

Frequenza
Frequency

Pannello comandi
Control panel

N. Programmi
N. programs

Lavaggio automatico
Automatic washing

Sonda al cuore
Core probe

Dimensioni (LxPxH)
Dimensions (WxDxH)

Peso
Weight

Generatore di vapore
Boiler



SMART
BLACK MASK
TOUCH SCREEN
TOUCH SCREEN
MKF 1021 S

Elettrico Electricity

MKF 1021 BM

Elettrico Electricity

MKF 1021 TS

Elettrico Electricity

MKF 1021 G TS

Gas

MKF 623 C

Forno combinato convezione

vapore 6 teglie 2/3 GN COMPATTO

COMPACT combi oven 6 trays 2/3 GN

Alimentazione

Power

Numero pasti

Number of meals

Numero teglie

Number of trays

Dimensioni teglia

Tray dimension

Passo guide

Rack rails distance

Temperatura

Temperature

Potenza - Portata termica

Power supply - Thermal supply

Voltaggio

Voltage

Frequenza

Frequency

Pannello comandi

Control panel

N. Programmi

N. programs

Lavaggio automatico

Automatic washing

Sonda al cuore

Core probe

Dimensioni (LxPxH)

Dimensions (WxDxH)

Peso

Weight

Generatore di vapore

Boiler

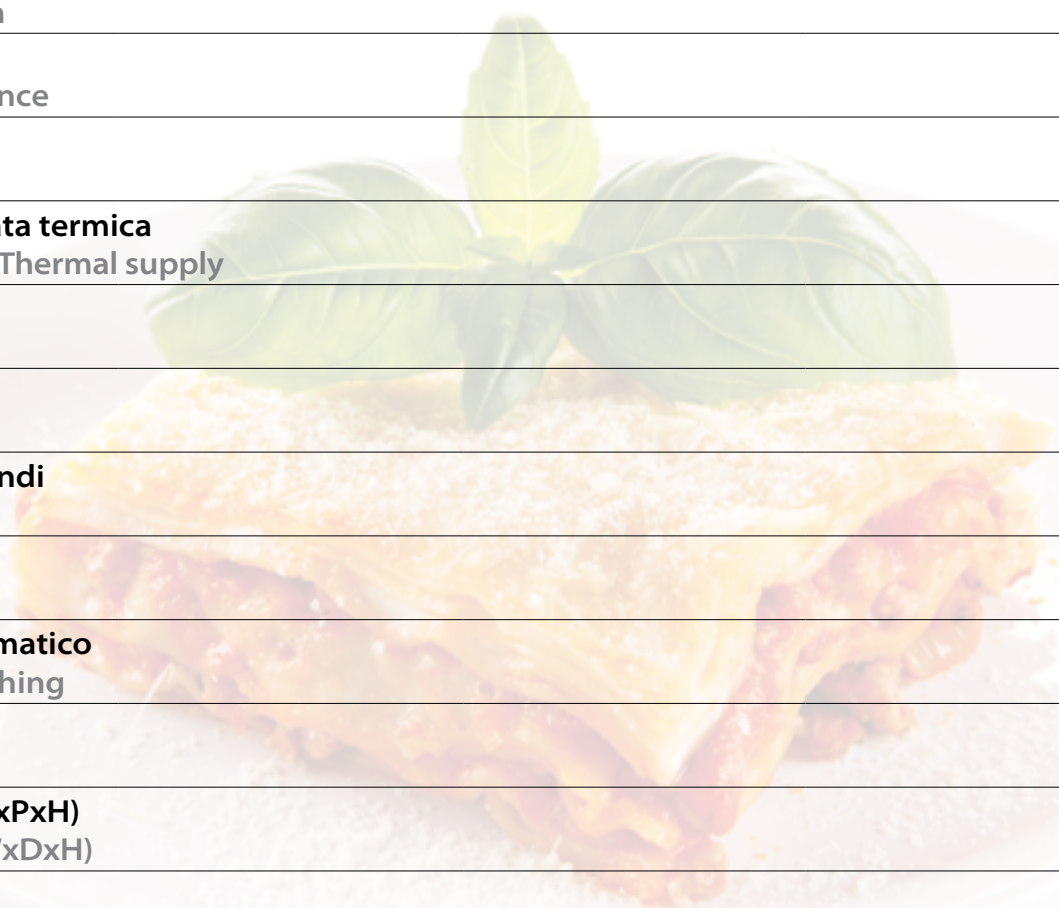

BLACK MASK COMPACT

TOUCH SCREEN COMPACT

MKF 623 C BM

MKF 623 C TS

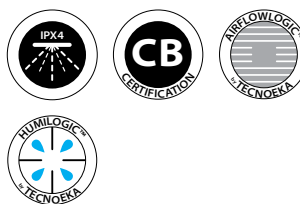

Elettrico 
Electricity

Elettrico 
Electricity

MKF 611 C

Forno combinato convezione

vapore 6 teglie 1/1 GN COMPATTO

COMPACT combi oven 6 trays 1/1 GN

Alimentazione

Power

Numero pasti

Number of meals

Numero teglie

Number of trays

Dimensioni teglia

Tray dimension

Passo guide

Rack rails distance

Temperatura

Temperature

Potenza - Portata termica

Power supply - Thermal supply

Voltaggio

Voltage

Frequenza

Frequency

Pannello comandi

Control panel

N. Programmi

N. programs

Lavaggio automatico

Automatic washing

Sonda al cuore

Core probe

Dimensioni (LxPxH)

Dimensions (WxDxH)

Peso

Weight

Generatore di vapore

Boiler

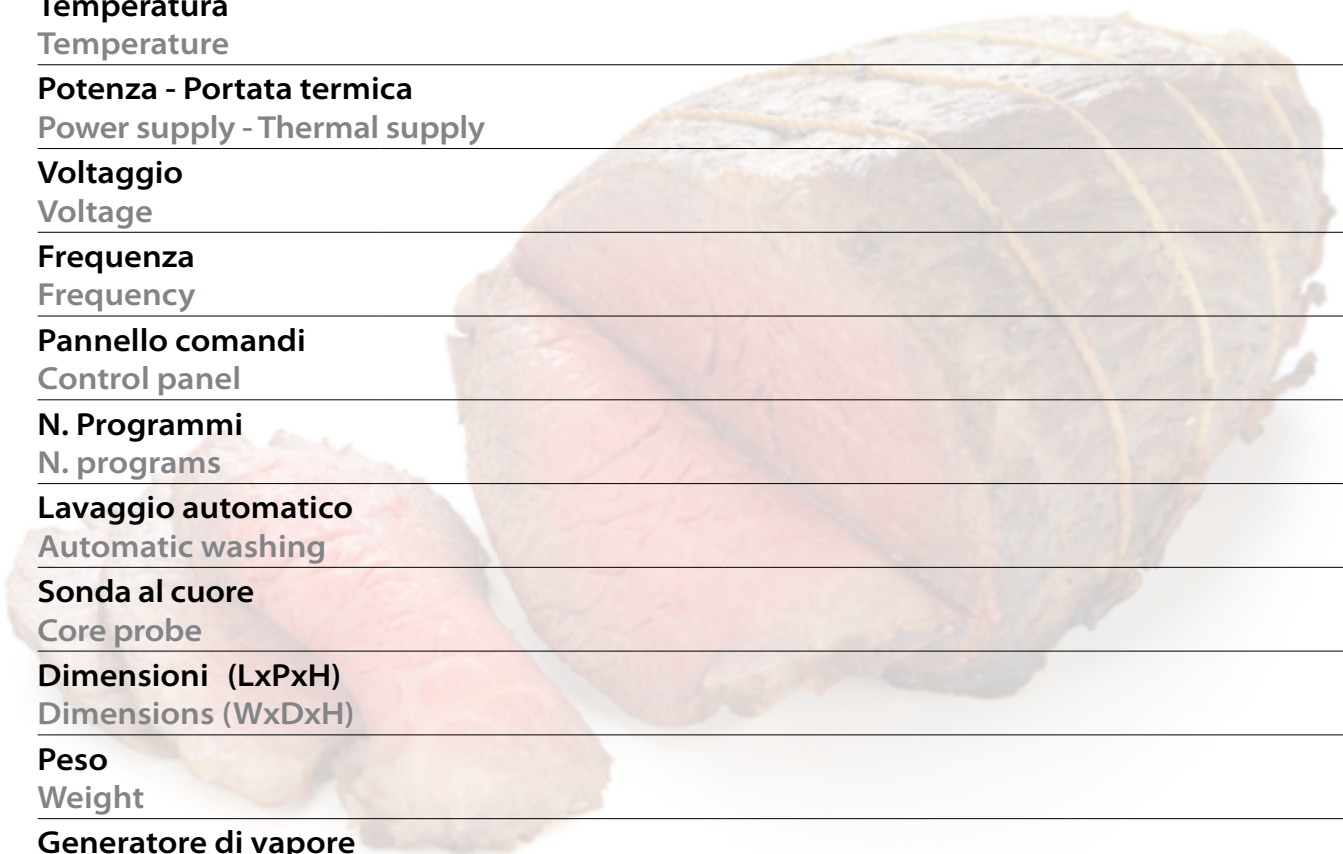

BLACK MASK COMPACT

TOUCH SCREEN COMPACT

TOUCH SCREEN COMPACT

MKF 611 C BM

MKF 611 C TS

MKF 611 V C TS

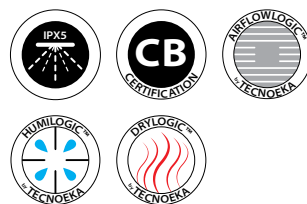
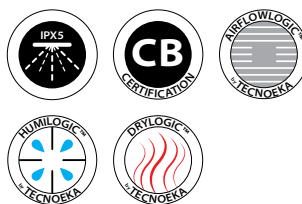

Elettrico Electricity

Elettrico Electricity

Elettrico Electricity

90 - 120

90 - 120

90 - 120

6

6

6

1/1 GN

1/1 GN

1/1 GN

68 mm

68 mm

68 mm

30 - 270 °C

30 - 270 °C

30 - 270 °C

7,8 kW

7,8 kW

11,4 kW

AC 380/400 3N

AC 380/400 3N

AC 380/400 3N

50/60 Hz

50/60 Hz

50/60 Hz

Black mask
electronic control

Touch screen

Touch screen

100

500

500

Incluso
Included

Incluso
Included

Incluso
Included

Inclusa EKSCS
Included EKSCS

Inclusa MKSCMU/A
Included MKSCMU/A

Inclusa MKSCMU/A
Included MKSCMU/A

500 x 930 x 700 mm
COMPACT

500 x 930 x 700 mm
COMPACT

500 x 930 x 700 mm
COMPACT

70,8 kg

70,8 kg

72,2 kg

/

/

Incluso Included

MKF 1011 C

Forno combinato convezione

vapore 10 teglie 1/1 GN COMPATTO

COMPACT combi oven 10 trays 1/1 GN

Alimentazione

Power

Numero pasti

Number of meals

Numero teglie

Number of trays

Dimensioni teglia

Tray dimension

Passo guide

Rack rails distance

Temperatura

Temperature

Potenza - Portata termica

Power supply - Thermal supply

Voltaggio

Voltage

Frequenza

Frequency

Pannello comandi

Control panel

N. Programmi

N. programs

Lavaggio automatico

Automatic washing

Sonda al cuore

Core probe

Dimensioni (LxPxH)

Dimensions (WxDxH)

Peso

Weight

Generatore di vapore

Boiler



BLACK MASK COMPACT

TOUCH SCREEN COMPACT

TOUCH SCREEN COMPACT

MKF 1011 C BM

MKF 1011 C TS

MKF 1011 V C TS



Elettrico Electricity

Elettrico Electricity

Elettrico Electricity

150 - 200

150 - 200

150 - 200

10

10

10

1/1 GN

1/1 GN

1/1 GN

68 mm

68 mm

68 mm

30 - 270 °C

30 - 270 °C

30 - 270 °C

15,4 kW

15,4 kW

19 kW

AC 380/400 3N

AC 380/400 3N

AC 380/400 3N

50/60 Hz

50/60 Hz

50/60 Hz

Black mask
electronic control

Touch screen

Touch screen

100

500

500

Incluso
Included

Incluso
Included

Incluso
Included

Inclusa EKSCS
Included EKSCS

Inclusa MKSCMU/A
Included MKSCMU/A

Inclusa MKSCMU/A
Included MKSCMU/A

500 x 930 x 970 mm
COMPACT

500 x 930 x 970 mm
COMPACT

500 x 930 x 970 mm
COMPACT

95,2 kg

95,2 kg

105 kg

/

/

Incluso Included

Mantenitori

Holding cabinets





MKM 1211

**Mantenitore elettrico per forni 5, 7 e 11 teglie
BM e TS, comandato dal forno**

**Electric holding cabinet for 5, 7 and 11 trays
BM and TS ovens, controlled by the oven**



Numero teglie Number of trays	12
Dimensioni teglia Tray dimension	1/1 GN
Passo guide Rack rails distance	75 mm
Temperatura Temperature	65 - 85 °C
Potenza Power supply	1,8 kW
Voltaggio Voltage	AC 220/230
Frequenza Frequency	50/60 Hz
Dimensioni (LxPxH) Dimensions (WxDxH)	730 x 875 x 770 mm
Peso Weight	70,8 kg

Cappe

Condensation hoods



MKKC 5

Cappa elettrica di aspirazione a condensazione
per forni 5 teglie BM e TS, comandata dal forno

Electric condensation hood for 5 trays
BM and TS ovens, controlled by the oven



Disponibile **MKKC 5 S** per forni 5 teglie S (MKF 511 S)

MKKC 5 S available for 5 trays S ovens (MKF 511 S)



Potenza Power supply	0,6 kW
Voltaggio Voltage	AC 220/230
Frequenza Frequency	50/60 Hz
Dimensioni (LxPxH) Dimensions (WxDxH)	730 x 860 x 308 mm
Peso Weight	26 kg

Gruppo condensazione di dimensioni inferiori rispetto al modello MKKC 711
Condensation unit smaller than the model MKKC 711

MKKC 711

Cappa elettrica di aspirazione a condensazione
per forni 7 e 11 teglie BM e TS, comandata dal forno

Electric condensation hood for 7 and 11 trays
BM and TS ovens, controlled by the oven

Disponibile **MKKC 711 S** per forni 7 e 11 teglie S
(MKF 711 S e MKF 1111 S)



MKKC 711 S available for 7 and 11 trays S ovens
(MKF 711 S and MKF 1111 S)



Potenza Power supply	0,6 kW
Voltaggio Voltage	AC 220/230
Frequenza Frequency	50/60 Hz
Dimensioni (LxPxH) Dimensions (WxDxH)	730 x 860 x 308 mm
Peso Weight	26 kg

MKKC 1620

Cappa elettrica di aspirazione a condensazione
per forni 16 e 20 teglie BM e TS, comandata dal forno

Electric condensation hood for 16 and 20 trays
BM and TS ovens, controlled by the oven

Disponibile **MKKC 1620 S** per forni 16 e 20 teglie S
(MKF 1664 S e MKF 2011 S)



MKKC 1620 S available for 16 and 20 trays S ovens
(MKF 1664 S and MKF 2011 S)



Potenza Power supply	0,6 kW
Voltaggio Voltage	AC 220/230
Frequenza Frequency	50/60 Hz
Dimensioni (LxPxH) Dimensions (WxDxH)	930 x 1045 x 308 mm
Peso Weight	31,4 kg

MKKC 610

Cappa elettrica di aspirazione a condensazione
per forni 6 e 10 teglie BM e TS, comandata dal forno

Electric condensation hood for 6 and 10 trays
BM and TS ovens, controlled by the oven

Disponibile **MKKC 610 S** per forni 6 e 10 teglie S
(MKF 664 S, MKF 621 S, MKF 1064 S e MKF 1021 S)

MKKC 610 S available for 6 and 10 trays S ovens
(MKF 664 S, MKF 621 S, MKF 1064 S and MKF 1021 S)



Potenza Power supply	0,6 kW
Voltaggio Voltage	AC 220/230
Frequenza Frequency	50/60 Hz
Dimensioni (LxPxH) Dimensions (WxDxH)	850 x 1045 x 308 mm
Peso Weight	29 kg

MKKC 623 C

**Cappa elettrica di aspirazione a condensazione
per forni 6 teglie 2/3 GN COMPATTI, comandata dal forno**

**Electric condensation hood for 6 trays 2/3 GN
COMPACT ovens, controlled by the oven**



Potenza Power supply	0,6 kW
Voltaggio Voltage	AC 220/230
Frequenza Frequency	50/60 Hz
Dimensioni (LxPxH) Dimensions (WxDxH)	500 x 762 x 308 mm
Peso Weight	17,6 kg

MKKC 610 C

**Cappa elettrica di aspirazione a condensazione
per forni 6 e 10 teglie COMPATTI, comandata dal forno**

Electric condensation hood for 6 and 10 trays

COMPACT ovens, controlled by the oven



Potenza Power supply	0,6 kW
Voltaggio Voltage	AC 220/230
Frequenza Frequency	50/60 Hz
Dimensioni (LxPxH) Dimensions (WxDxH)	500 x 942 x 308 mm
Peso Weight	19 kg



Tavoli e carrelli

Tables and trolleys



MKTS 11

Tavolo fisso in AISI 430 con supporti per forni 5 - 7 - 11 teglie,
per MKF 511 con kit sovrapposizione forni
con supporto teglie MKSST 511;
per MKF 711 con kit sovrapposizione forni MKST 711;
per MKF 1111 con kit sovrapposizione forni MKS 11

AISI 430 fixed table with supports for ovens 5 - 7- 11 trays,
for MKF 511 with kit for overlapping ovens
with tray supports MKSST 511;
for MKF 711 with kit for overlapping ovens MKST 711;
for MKF 1111 with kit for overlapping ovens MKS 11
730 x 600 x 770 mm
per mod - for mod: MKF 511, MKF 711, MKF 1111



MKT 11 D

Tavolo fisso in AISI 430 per forni 5 - 7 - 11 teglie
(per sovrapposizione forni),
per MKF 511 con kit sovrapposizione forni
con supporto teglie MKSST 511;
per MKF 711 con kit sovrapposizione forni MKS 11;
per MKF 1111 con kit sovrapposizione forni MKS 11

AISI 430 fixed table for ovens 5 - 7- 11 trays (for overlapping ovens),
for MKF 511 with kit for overlapping ovens
with tray supports MKSST 511;
for MKF 711 with kit for overlapping ovens MKS 11;
for MKF 1111 with kit for overlapping ovens MKS 11
730 x 600 x 220 mm
per mod - for mod: MKF 511, MKF 711, MKF 1111



MKTS 21

Tavolo fisso in AISI 430 con supporti per forni 6 - 10 teglie 2/1 GN,
per MKF 621 con kit sovrapposizione forni MKST 664;
per MKF 1021 con kit sovrapposizione forni MKS 64

AISI 430 fixed table with supports for ovens 6- 10 trays 2/1 GN,
for MKF 621 with kit for overlapping oven MKST 664;
for MKF 1021 with kit for overlapping ovens MKS 64
850 x 787 x 770 mm
per mod - for mod: MKF 621, MKF 1021



MKT 64 D

Tavolo fisso in AISI 430 per forni 4 - 6 - 10 teglie
(per sovrapposizione forni),
per MKF 464 con kit sovrapposizione forni
con supporti teglie MKSST 464;
per MKF 664 e MKF 621 con kit sovrapposizione forni MKS 64;
per MKF 1064 e MKF 1021 con kit sovrapposizione forni MKS 64

AISI 430 fixed table, for ovens 4 - 6- 10 trays
(for overlapping ovens),
for MKF 464 with kit for overlapping ovens
with tray supports MKSST 464;
for MKF 664 and MKF 621 with kit for overlapping oven MKS 64;
for MKF 1064 and MKF 1021 with kit for overlapping oven MKS 64
850 x 787 x 220 mm
per mod - for mod: MKF 464, MKF 664, MKF 1064, MKF 621, MKF 1021



MKTS 623 C

Tavolo fisso in AISI 430 con supporti, per MKF 623 C con kit sovrapposizione forni con supporto teglie MKSST 623 C

AISI 430 fixed table with supports, for MKF 623 C with kit for overlapping ovens with tray supports MKSST 623 C
500 x 556 x 770 mm
per mod - for mod: MKF 623 C



MKT 623 D C

Tavolo fisso in AISI 430 (per sovrapposizione forni), per MKF 623 C con kit sovrapposizione forni MKS 623 C

AISI 430 fixed table (for overlapping ovens), for MKF 623 C with kit for overlapping ovens MKS 623 C
500 x 556 x 220 mm
per mod - for mod: MKF 623 C



MKTS 11 C

Tavolo fisso in AISI 430 con supporti per forni 6 - 10 teglie compatti, per MKF 611 C con kit sovrapposizione forni con supporto teglie MKSST 611 C; per MKF 1011 C con kit sovrapposizione forni MKS 11 C

AISI 430 fixed table with supports for compact ovens 6 - 10 trays, for MKF 611 C with kit for overlapping ovens with tray supports MKSST 611 C; for MKF 1011 C with kit for overlapping ovens MKS 11 C
500 x 736 x 770 mm
per mod - for mod: MKF 611 C, MKF 1011 C



MKT 11 D C

Tavolo fisso in AISI 430 per forni 6 teglie compatti (per sovrapposizione forni), per MKF 611 C con kit sovrapposizione forni con supporto teglie MKSST 611 C

AISI 430 fixed table for compact ovens 6 trays (for overlapping ovens), for MKF 611 C with kit for overlapping ovens with tray supports MKSST 611 C
500 x 736 x 220 mm
per mod - for mod: MKF 611 C



MKTPL

Tavolo polli chiuso in AISI 430 fisso con kit raccogli grasso e 2 taniche da 10 lt incluse

AISI 430 closet with kit for fat collection and 2 tanks included 10 lt
730 x 666 x 770 mm
per mod - for mod: MKF 711 BM, MKF 711 TS, MKF 1111 BM, MKF 1111 TS (con scarico grassi - with fat drain)



EKCR 20 TC











Carrello estraibile in AISI 304 con impugnatura ergonomica asportabile e ruote frenanti, per forni 20 teglie

AISI 304 pull-out trolley with removable handle and braked wheels, for 20 trays ovens
660 x 560 x 1704 mm
per mod - for mod: MKF 2011

Complementi Optionals



	EKKD	<p>Kit doccia completo di supporto doccia, tubo e relativa predisposizione per mod: tutti i forni millennial tranne MKF 664 SP, MKF D1T e MKF D2T</p> <p>Spray kit with support and tube for mod: all millennial ovens except MKF 664 SP, MKF D1T and MKF D2T</p>
	MKSCMO	<p>Sonda al cuore monopunto per mod: tutti i forni millennial TS</p> <p>Single-point core probe for mod: all TS millennial ovens</p>
	MKSCMU/A	<p>Sonda al cuore multipunto (3 punti) per mod: tutti i forni millennial TS</p> <p>Multi-point core probe (3 points) for mod: all TS millennial ovens</p>
	MKSCSV	<p>Sonda al cuore cottura "sottovuoto" per mod: tutti i forni millennial TS</p> <p>Vacuum cooking core probe for mod: all TS millennial ovens</p>
	MKSSC/A	<p>Supporto sonda al cuore per mod: tutti i forni millennial TS</p> <p>Support for core probe for mod: all TS millennial ovens</p>
	EKSCS	<p>Sonda al cuore con supporto per mod: tutti i forni millennial BM</p> <p>Core probe with support for mod: all BM millennial ovens</p>
	MKAFF	<p>Affumicatore per mod: tutti i forni millennial</p> <p>Smoker for mod: all millennial ovens</p>
	MKCG	<p>Concentratore grasso in AISI 304 per mod: tutti i forni millennial 1/1 GN TS e BM</p> <p>AISI 304 Fat concentrator for mod: all TS and BM 1/1 GN millennial ovens 205 x 205 mm</p>
	EKFCA	<p>Filtro carboni attivi per mod: tutte le cappe millennial</p> <p>Activated carbon filter for mod: all millennial condensation hoods 364 x 315 x 258 mm</p>
	RCA	<p>Ricarica carboni attivi</p> <p>Activated carbon 25 kg per mod - for mod: EKFCA</p>
	MKBZ	<p>Buzzer potenziato per forni millennial per mod: tutti i forni millennial TS</p> <p>Boosted buzzer for millennial ovens for mod: all TS millennial ovens</p>

	MKWT	Sistema di lavaggio automatico per mod: tutti i forni millennial BM Automatic washing system for mod: all BM millennial ovens
	MKDET	Detergente e brillantante per mod: tutti i forni millennial TS e BM Detergent and rinse aid for mod: all TS and BM millennial ovens 12 kg
	MKDETS	Detergente e brillantante per mod: tutti i forni millennial TS e BM Detergent and rinse aid for mod: all TS and BM millennial ovens 6 kg
	KAF	Addolcitore LT. 8 capacità: 1000 Lt/h per mod: tutti i forni millennial tranne MKF 664 SP Water softener LT.8 capacity: 1000 Lt/h for mod: all millennial ovens except MKF 664 S P
	KTA	Testata di connessione cartuccia filtrante per trattamento acqua potabile per mod: tutti i forni millennial tranne MKF 664 SP Filter head for water optimisation for mod: all millennial ovens except MKF 664 S P
	KCA	Cartuccia filtrante per trattamento acqua potabile per mod: tutti i forni millennial tranne MKF 664 SP Filter for water optimisation for mod: all millennial ovens except MKF 664 S P
	MKKR	Kit ruote (2 ruote piroettanti con freno, 2 ruote piroettanti senza freno) Set of wheels (2 rotating wheels with brake, 2 rotating wheels without brake) H 110 mm per mod - for mod: MKTS 11, MKTS 623 C, MKTS 11 C, MKTS 64, MKTS 21
	MKKPI	Kit prima installazione per forni millennial TS, BM e S (non compatti) First installation kit for millennial TS, BM and S ovens (no compact ovens)
	MKKPIC	Kit prima installazione per forni millennial TS e BM compatti First installation kit for millennial TS and BM compact ovens
	MKCKIT	Kit cappa Millennial per forni TS e BM sovrapposti per mod: tutte le cappe dei forni millennial TS e BM tranne MKKC 1620 Millennial condensation hood kit for overlapped ovens for mod: all condensation hoods for millennial TS e BM ovens except MKKC 1620
	MKCSKIT	Kit cappa Millennial per forni S sovrapposti per mod: tutte le cappe dei forni millennial S tranne MKKC 1620 S Millennial condensation hood kit for overlapped ovens for mod: all condensation hoods for millennial S ovens except MKKC 1620 S

Complementi

Optionals



MKS 11

Kit sovrapposizione forni in AISI 430 H 55 mm
per sovrapposizione MKF 511 a MKF 511 oppure a MKF 1111;
per sovrapposizione MKF 711 a MKF 711 oppure a MKT 11 D;
per sovrapposizione MKF1111 a MKM 1211 o a MKT 11 D
oppure a MKTS 11;
per sovrapposizione MKF 1111 (con scarico grassi) a MKTPL

AISI 430 kit for overlapping ovens H 55 mm
for overlapping MKF 511 with MKF 511 or with MKF 1111;
for overlapping MKF 711 with MKF 711 or with MKT 11 D;
for overlapping MKF1111 with MKM 1211 or
MKT 11 D or with MKTS 11;
for overlapping MKF 1111 (with fat drain) with MKTPL
per mod - for mod: MKF 511, MKF 711, MKF 1111



MKST 711

Kit sovrapposizione forni in AISI 430 H 180 mm
per sovrapposizione MKF 711 a MKM 1211 oppure a MKTS 11;
per sovrapposizione MKF 711 (con scarico grassi) a MKTPL

AISI 430 kit for overlapping ovens H 180 mm
for overlapping MKF 711 with MKM 1211 or with MKTS 11;
for overlapping MKF 711 (with fat drain) with MKTPL
per mod - for mod: MKF 711



MKSST 511

Kit sovrapposizione forni con supporti teglie in AISI 430,
capacità 3 teglie 1/1 GN per sovrapposizione MKF 511 a MKM 1211 o
a MKT 11 D oppure a MKTS 11







AISI 430 kit for overlapping ovens with trays supports,
capacity of 3 trays 1/1 GN for overlapping MKF 511 with MKM 1211 or
MKT 11 D or with a MKTS 11
per mod - for mod: MKF 511



MKS 64

Kit sovrapposizione forni in AISI 430 H 55 mm
per sovrapposizione MKF 464 a MKF 464, MKF 1064
oppure a MKF D1T;
per sovrapposizione MKF 664 o MKF 621 a MKF 664,
MKF 621, MKF D1T oppure a MKT 64 D;
per sovrapposizione MKF 1064 a MKLM 1064, MKL 1064 S o
a MKT 64 D oppure a MKTS 64;
per sovrapposizione MKF D1T a MKTS 64, MKLM 1064
oppure a MKL 1064 S;
per sovrapposizione MKF D2T a MKTSD 2T;
per sovrapposizione MKF 1021 a MKT 64 D oppure a MKTS 21

AISI 430 kit for overlapping ovens H 55 mm
for overlapping MKF 464 with MKF 464 or with MKF 1064
or with MKF D1T;
for overlapping MKF 664 or MKF 621 with MKF 664,
MKF 621, MKF D1T or with MKT 64 D;
for overlapping MKF 1064 with MKLM 1064, MKL 1064 S,
MKT 64 D or with MKTS 64;
for overlapping MKF D1T with MKTS 64, MKLM 1064 or with MKL 1064 S;
for overlapping MKF D2T with MKTSD 2T;
for overlapping MKF 1021 with MKT 64 D or with MKTS 21
per mod - for mod: MKF 464, MKF 664, MKF 1064,
MKF D1T, MKF D2T, MKF 621 MKF 1021

	MKST 664	<p>Kit sovrapposizione forni in AISI 430 H 180 mm per sovrapposizione MKF 664 a MKLM 1064, MKL 1064 S oppure a MKTS 64; per sovrapposizione MKF 621 a MKTS 21</p> <p>AISI 430 kit for overlapping ovens H 180 mm for overlapping MKF 664 with MKLM 1064, MKL 1064 S or with MKTS 64; for overlapping MKF 621 with MKTS 21 per mod - for mod: MKF 664, MKF 621</p>
	MKS 23 C	<p>Kit sovrapposizione forni compatti in AISI 430 H 55 mm per sovrapposizione MKF 623 C a MKF 623 C</p> <p>AISI 430 kit for overlapping compact ovens H 55 mm for overlapping MKF 623 C with MKF 623 C per mod - for mod: MKF 623 C</p>
	MKS 623 C	<p>Kit sovrapposizione forni compatti in AISI 430 H 55 mm per sovrapposizione MKF 623 C a MKT 623 D C</p> <p>AISI 430 kit for overlapping compact ovens H 55 mm for overlapping MKF 623 C with MKT 623 D C per mod - for mod: MKF 623 C</p>
	MKSST 623 C	<p>Kit sovrapposizione forni con supporti teglie in AISI 430, capacità 3 teglie 2/3 GN per sovrapposizione MKF 623 C con MKTS 623 C</p> <p>AISI 430 kit for overlapping ovens with trays supports, capacity of 3 trays 2/3 GN for overlapping MKF 623 C with MKTS 623 C per mod - for mod: MKF 623 C</p>
	MKS 11 C	<p>Kit sovrapposizione forni compatti in AISI 430 H 55 mm per sovrapposizione MKF 611 C a MKF 611 C</p> <p>AISI 430 kit for overlapping compact ovens H 55 mm for overlapping MKF 611 C with MKF 611 C per mod - for mod: MKF 611 C</p>
	MKS 611 C	<p>Kit sovrapposizione forni compatti in AISI 430 H 55 mm per sovrapposizione MKF 611 C a MKSST 611 C; per sovrapposizione MKF 1011 C a MKTS 11 C</p> <p>AISI 430 kit for overlapping compact ovens H 55 mm for overlapping MKF 611 C with MKSST 611 C; for overlapping MKF 1011 C with MKTS 11 C per mod - for mod: MKF 611 C, MKF 1011 C</p>
	MKSST 611 C	<p>Kit sovrapposizione forni compatti con supporti teglie in AISI 430, capacità 3 teglie 1/1 GN per sovrapposizione MKF 611 C a MKT 11 D C oppure a MKTS 11 C</p> <p>AISI 430 kit for overlapping compact ovens with trays supports, capacity of 3 trays 1/1 GN for overlapping MKF 611 C with MKT 11 D C or with MKTS 11 C per mod - for mod: MKF 611 C</p>

Teglie e griglie

Trays and grids



Teglie e griglie per forni 2/3 GN
Trays and grids for 2/3 GN ovens

**FOOD CONTACT
CERTIFICATE**



KT6G

Teglia in AISI 304 2/3 GN

AISI 304 Tray 2/3 GN
354 x 325 x 23 mm
per mod - for mod: MKF 623 C

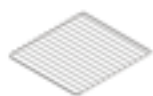

KG6X

Griglia in AISI 304 2/3 GN

AISI 304 grid 2/3 GN
353 x 325 x 11 mm
per mod - for mod: MKF 623 C

Teglie e griglie per forni 2/1 GN
Trays and grids for 2/1 GN ovens



KT21G

Teglia in AISI 304 2/1 GN
per mod: tutti i forni millennial 2/1 GN

AISI 304 Tray 2/1 GN
for mod: all millennial ovens 2/1 GN
650 x 530 x 42 mm



KG21G

Griglia in AISI 304 2/1 GN
per mod: tutti i forni millennial 2/1 GN

AISI 304 grid 2/1 GN
for mod: all millennial ovens 2/1 GN
650 x 530 x 11 mm

Teglie e griglie per forni 1/1 GN
Trays and grids for 1/1 GN ovens



KT9G

Teglia in AISI 304 1/1 GN
per mod: tutti i forni millennial 1/1 GN

AISI 304 Tray 1/1 GN
for mod: all millennial ovens 1/1 GN
530 x 325 x 40 mm



KT9G2 

Teglia in AISI 304 1/1 GN
per mod: tutti i forni millennial 1/1 GN

AISI 304 Tray 1/1 GN
for mod: all millennial ovens 1/1 GN
530 x 325 x 20 mm

	KFT9G	Teglia forata in AISI 304 1/1 GN per mod: tutti i forni millennial 1/1 GN
		AISI 304 Perforated tray 1/1 GN for mod: all millennial ovens 1/1 GN 530 x 325 x 40 mm
	KFT9G2 	Teglia forata in AISI 304 1/1 GN per mod: tutti i forni millennial 1/1 GN
		AISI 304 Perforated tray 1/1 GN for mod: all millennial ovens 1/1 GN 530 x 325 x 20 mm
	KG9G	Griglia cromata 1/1 GN per mod: tutti i forni millennial 1/1 GN
		Chromed grid 1/1 GN for mod: all millennial ovens 1/1 GN 530 x 325 x 12 mm
	KG9GX	Griglia in AISI 304 1/1 GN per mod: tutti i forni millennial 1/1 GN
		AISI 304 grid 1/1 GN for mod: all millennial ovens 1/1 GN 530 x 325 x 12 mm
	KPGL11A	Piastra liscia in alluminio con rivestimento antiaderente 1/1 GN per mod: tutti i forni millennial 1/1 GN
		Smooth plate with non-stick coating 1/1 GN for mod: all millennial ovens 1/1 GN 530 x 325 x 7 mm
	KPGR11A	Piastra rigata in alluminio con rivestimento antiaderente 1/1 GN per mod: tutti i forni millennial 1/1 GN
		Striped plate with non-stick coating 1/1 GN for mod: all millennial ovens 1/1 GN 530 x 325 x 20 mm
	MKT11RG	Teglia in AISI 304 1/1 GN raccogli grasso
		AISI 304 fat drip pan grid 1/1 GN 533 x 345 x 41 mm per mod - for mod: MKF 511, MKF 711, MKF 1111
	EKT11RGC	Teglia in AISI 304 1/1 GN raccogli grasso per forni 6 - 10 teglie compatti
		AISI 304 fat drip pan grid 1/1 GN, for compact ovens 6 -10 trays 531,5 x 330 x 40 mm per mod - for mod: MKF 611 C, MKF 1011 C
	KGP	Griglia in AISI 304 1/1 GN per cottura verticale di nr. 8 polli
		AISI 304 vertical cooking grid for 8 chicken 1/1 GN 530 x 325 x 148,1 mm per mod - for mod: MKF 511, MKF 711, MKF 1111, MKF 611 C, MKF 1011 C
	KGC075	Griglia in AISI 304 1/1 GN per cottura costicine
		AISI 304 grid for cooking ribs 1/1 GN 530 x 325 x 123 mm per mod - for mod: MKF 511, MKF 711, MKF 1111, MKF 611 C, MKF 1011 C
	EKTF11	Teglia forata in AISI 304 1/1 GN per cottura nuggets
		AISI 304 Perforated tray 1/1 GN, for cooking nuggets 533 x 330 x 38,5 mm per mod - for mod: MKF 511, MKF 711, MKF 1111, MKF 611 C, MKF 1011 C
	EKTF11PT/A 	Teglia in alluminio forata con rivestimento in teflon 1/1 GN per mod: tutti i forni millennial 1/1 GN
		Perforated aluminium tray teflon coated 1/1 GN for mod: all millennial ovens 1/1 GN 530 x 325 x 20 mm

Modular design 1/1 GN

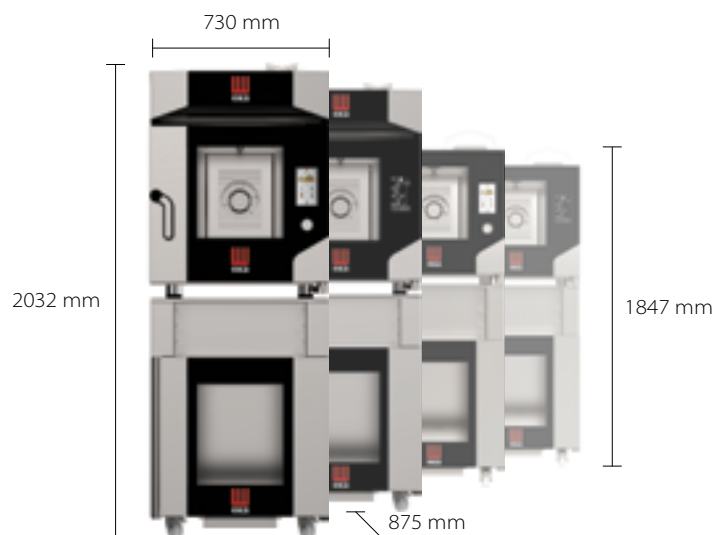

MKF 511 - 5 teglie/trays

MKM 1211 + MKSST 511
+ MKF 511 TS** + MKKC 5

**Disponibile versione BM, G TS e G BM (senza cappa)
**BM version available, G TS and GBM (without hood)

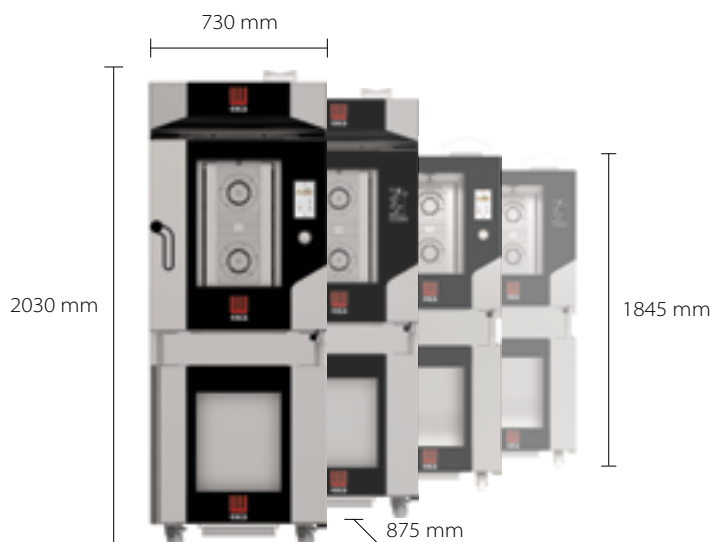

MKF 711 - 7 teglie/trays

MKM 1211 + MKST 711
+ MKF 711 TS** + MKKC 711

**Disponibile versione BM, G TS e G BM (senza cappa)
**BM version available, G TS and GBM (without hood)



MKF 1111 - 11 teglie/trays

MKM 1211 + MKS 11
+ MKF 1111 TS** + MKKC 711

**Disponibile versione BM, G TS e G BM (senza cappa)
**BM version available, G TS and GBM (without hood)

MKF 511 - 5 teglie/trays

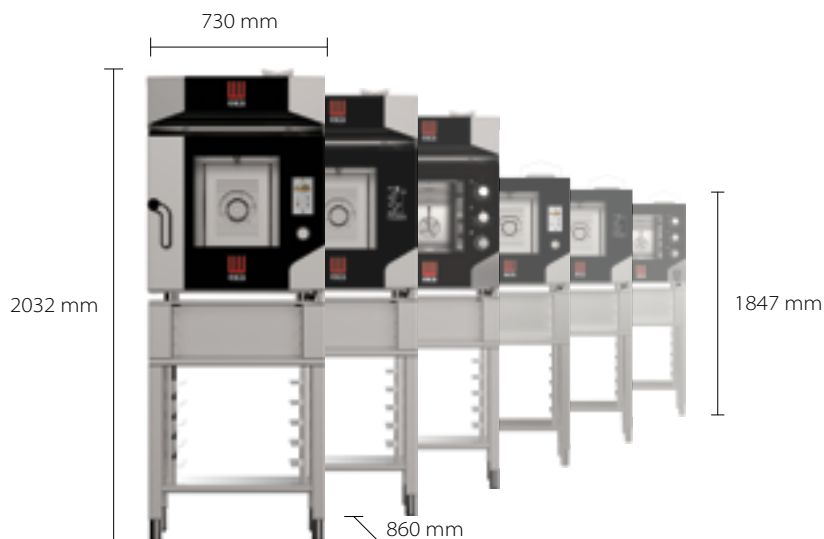

MKTS 11 + MKSST 511
+ MKF 511 TS** + MKKC 5***

**Disponibile versione BM, S e
G TS, G BM, G S (senza cappa)

***Disponibile versione MKKC 5 S per forno S

**BM, S version available, G TS, G BM, G S (without hood)

***MKKC 5 S version available for S oven

MKF 711 - 7 teglie/trays

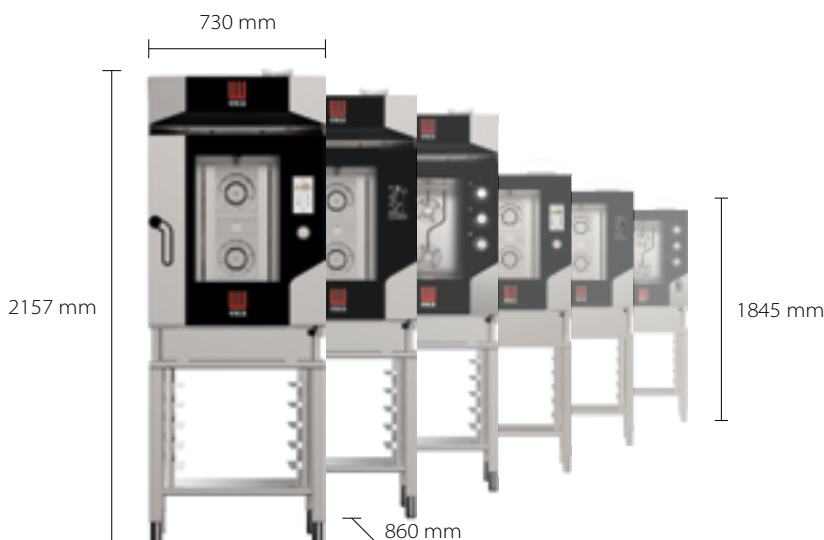

MKTS 11 + MKST 711
+ MKF 711 TS** + MKKC 711***

**Disponibile versione BM, S e
G TS, G BM, G S (senza cappa)

***Disponibile versione MKKC 711 S per forno S

**BM, S version available, G TS, G BM, G S (without hood)

***MKKC 711 S version available for S oven

MKF 1111 - 11 teglie/trays



MKTS 11 + MKS 11
+ MKF 1111 TS** + MKKC 711***

**Disponibile versione BM, S e
G TS, G BM, G S (senza cappa)

***Disponibile versione MKKC 711 S per forno S

**BM, S version available,
G TS, G BM, G S (without hood)

***MKKC 711 S version available for S oven

MKF 2011 - 20 teglie/trays

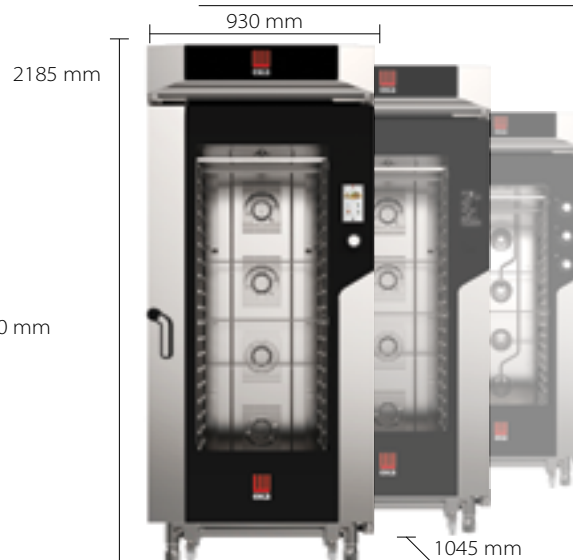

MKF 2011 TS** + MKKC 1620***

**Disponibile versione BM e S
***Disponibile versione MKKC 1620 S
per forno S

**BM, S version available
***MKKC 1620 S version
available for S oven

Modular design 1/1 GN

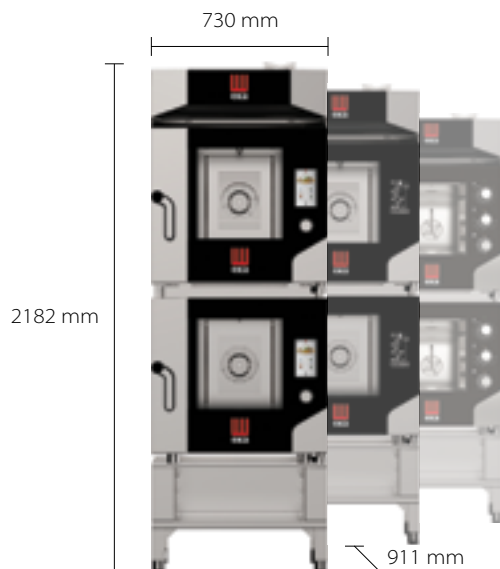

MKF 511 - 5 + 5 teglie/trays

* MKT 11 D + MKSST 511 + MKF 511 TS**
+ MKS 11 + MKF 511 TS** + MKKC 711*** + MKCKIT

**Disponibile versione BM e S
***Disponibile versione MKKC 711 S per forno S



MKF 711 - 7 + 7 teglie/trays

* MKT 11 D + MKS 11 + MKF 711 TS**
+ MKS 11 + MKF 711 TS** + MKKC 711*** + MKCKIT

**Disponibile versione BM e S
***Disponibile versione MKKC 711 S per forno S



**MKF 1111 - MKF 511
11 + 5 teglie/trays**

* MKT 11 D + MKS 11 + MKF 1111 TS**
+ MKS 11 + MKF 511 TS** + MKKC 711*** + MKCKIT

**Disponibile versione BM e S
***Disponibile versione MKKC 711 S per forno S

* In caso di sovrapposizione tra due forni la profondità totale della colonna aumenta di 62 mm
* In case of overlap between two ovens the total depth of the column increases by 62 mm

**BM, S version available
***MKKC 711 S version available for S oven

Modular design 2/1 GN

MKF 621 - 6 teglie/trays

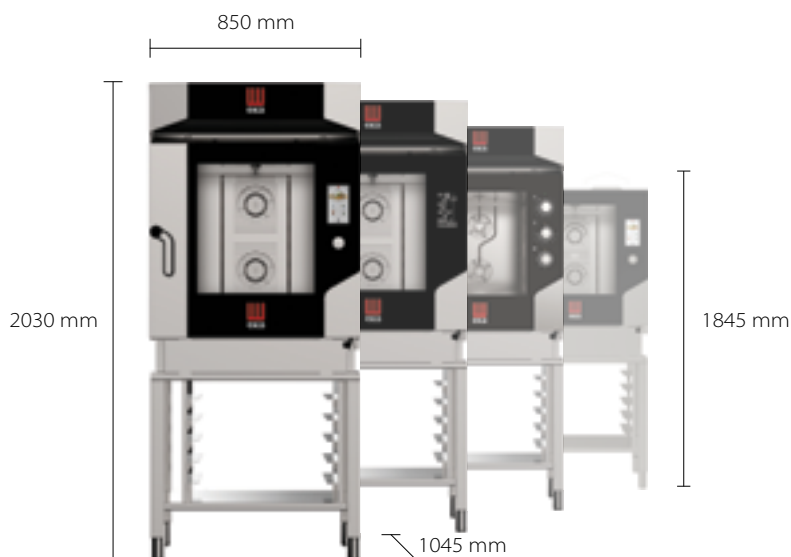

MKTS 21 + MKST 664
+ MKF 621 TS** + MKKC 610***

**Disponibile versione BM, S e GTS (senza cappa)
***Disponibile versione MKKC 610 S per forno S

MKF 1021 - 10 teglie/trays

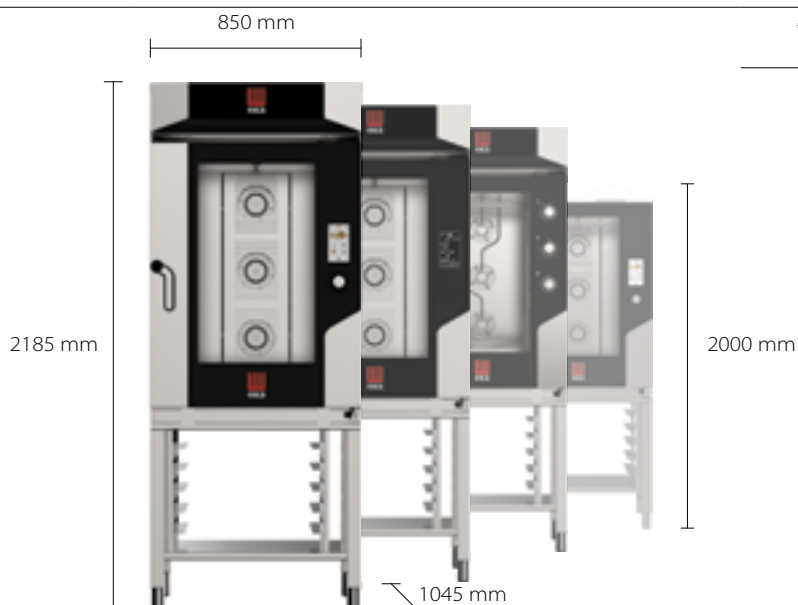

MKTS 21 + MKS 64
+ MKF 1021 TS** + MKKC 610***

**Disponibile versione BM, S e GTS (senza cappa)
***Disponibile versione MKKC 610 S per forno S

MKF 621 - 6 + 6 teglie/trays

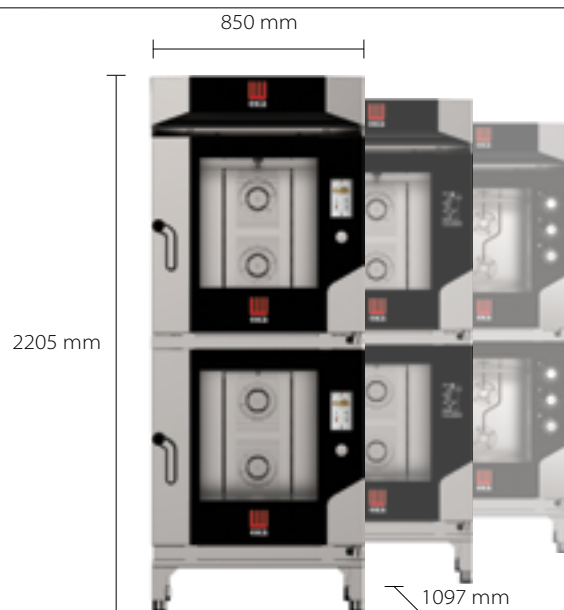

* MKT 64 D + MKS 64 + MKF 621 TS**
+ MKS 64 + MKF 621 TS** + MKKC 610*** + MKCKIT

**Disponibile versione BM, S
***Disponibile versione MKKC 610 S per forno S

* In caso di sovrapposizione tra due forni la profondità totale della colonna aumenta di 62 mm
* In case of overlap between two ovens the total depth of the column increases by 62 mm

**BM, S version available
***MKKC 610 S version available for S oven

Modular design COMPACT



MKF 623 - 6 teglie/trays

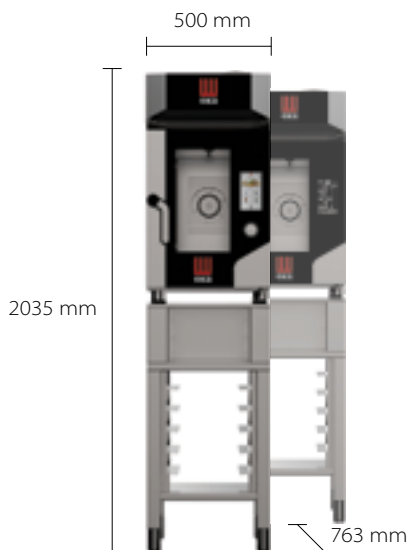

MKTS 623 C + MKSST 623 C +
MKF 623 CTS** + MKKC 623 C

**Disponibile versione BM
**BM version available

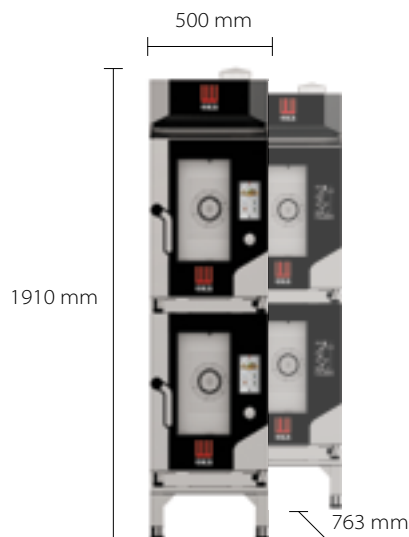

MKT 623 D C + MKS 623 C + MKF 623 CTS
+ MKS 23 C + MKF 623 CTS +
MKKC 623 C + MKCKIT

**Disponibile versione BM
**BM version available

MKF 611 - 6 teglie/trays

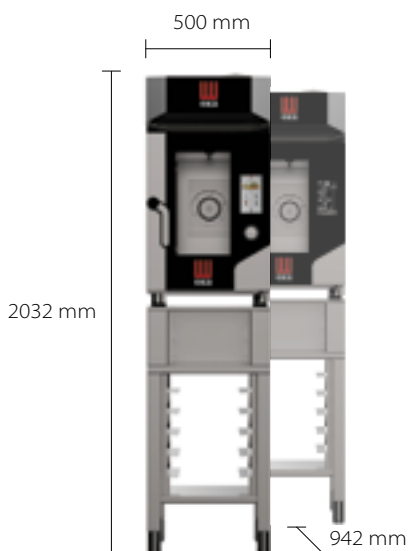

MKTS 11 C + MKSST 611 C
+ MKF 611 CTS** + MKKC 610 C

**Disponibile versione BM
**BM version available

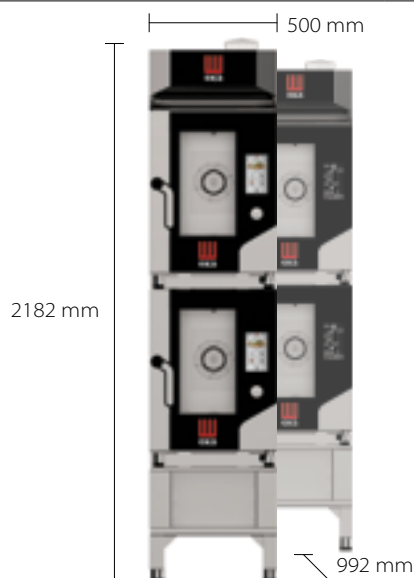

* MKT 11 D C + MKSST 611 C + MKS 611 C
+ MKF 611 CTS** + MKS 11 C + MKF 611 CTS** +
MKKC 610 C + MKCKIT

**Disponibile versione BM
**BM version available

MKF 1011 - 10 teglie/trays

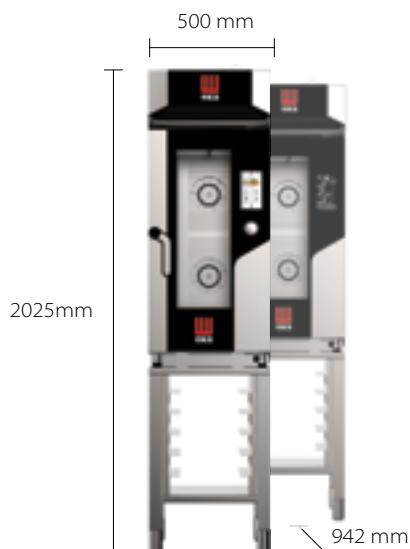

MKTS 11 C + MKS 11 C
+ MKF 1011 CTS + MKKC 610 C

**Disponibile versione BM
**BM version available

* In caso di sovrapposizione tra due forni la profondità totale della colonna aumenta di 62 mm
* In case of overlap between two ovens the total depth of the column increases by 62 mm

	MKF 511 S	MKF 511 BM	MKF 511 TS	MKF 711 S	MKF 711 BM	MKF 711 TS	MKF 711 VTS	MKF 1111 S	MKF 1111 BM	MKF 1111 TS	MKF 1111 VTS	MKF 2011 S	MKF 2011 BM	MKF 2011 TS	MKF 621 S	MKF 621 BM	MKF 621 TS	MKF 1021 S	MKF 1021 BM
MKM 1211		●	●		●	●	●		●	●	●								
MKL 1064 S																			
MKLM 1064																			
MKCC 5 S	●																		
MKCC 5		●	●																
MKCC 711 S	●			●															
MKCC 711		●	●		●	●	●		●	●	●								
MKCC 1620 S												●							
MKCC 1620													●	●					
MKCC 623 C																			
MKCC 610 C																			
MKCC 4 S																			
MKCC 4																			
MKCC 610 S															●			●	
MKCC 610																●			●
MKTS 11	●	●	●	●	●	●	●	●	●	●	●								
MKT 11 D	●	●	●	●	●	●	●	●	●	●	●								
MKTS 21															●	●	●	●	●
MKTS 623 C																			
MKT 623 D C																			
MKTS 11 C																			
MKT 11 D C																			
MKTPL					●	●			●	●									
MKTS 64																			
MKT 64 D															●	●	●		
MKTSD 2T																			
EKCR 20 TC												●	●	●					
EKCR 16 TC																			
EKCR 1664																			
EKGD	●	●	●	●	●	●	●	●	●	●	●	●	●	●	●	●	●	●	●
MKSCMO			●			●	●		●	●	●						●		
MKSCMU/A			●			●	●		●	●	●						●		
MKSCSV			●			●	●		●	●	●						●		
MKSSC/A			●			●	●		●	●	●						●		
EKSCS		●			●				●				●			●			●
MKAF	●	●	●	●	●	●	●	●	●	●	●	●	●	●	●	●	●	●	●
MKCG		●	●		●	●	●		●	●	●		●	●	●	●	●	●	●
EKFA	●	●	●	●	●	●	●	●	●	●	●	●	●	●	●	●	●	●	●
RCA	●	●	●	●	●	●	●	●	●	●	●	●	●	●	●	●	●	●	●
MKBZ			●			●	●		●	●	●				●		●		●
MKWT		●			●				●				●			●			●
MKDET		●	●		●	●	●		●	●	●		●			●			●
MKDETS		●	●		●	●	●		●	●	●		●			●			●
KAF	●	●	●	●	●	●	●	●	●	●	●	●	●	●	●	●	●	●	●
KTA	●	●	●	●	●	●	●	●	●	●	●	●	●	●	●	●	●	●	●
KCA	●	●	●	●	●	●	●	●	●	●	●	●	●	●	●	●	●	●	●
MKKPI	●	●	●	●	●	●	●	●	●	●	●	●	●	●	●	●	●	●	●
MKKPIC																			
MKCKIT		●	●		●	●	●		●	●	●				●	●	●		●
MKCSKIT	●			●				●							●			●	
MKS 11	●	●	●	●	●	●	●	●	●	●	●								
MKS 23 C																			
MKS 623 C																			
MKS 11 C																			
MKS 611 C																			
MKST 711				●	●	●	●												
MKSST 511	●	●	●																
MKSST 623 C																			
MKSST 611 C																			
MKS 64															●	●	●	●	●
MKST 664															●	●	●		
MKSST 464																			
KT9G	●	●	●	●	●	●	●	●	●	●	●	●	●	●					
KT9G2	●	●	●	●	●	●	●	●	●	●	●	●	●	●					
KFT9G	●	●	●	●	●	●	●	●	●	●	●	●	●	●					
KFT9G2	●	●	●	●	●	●	●	●	●	●	●	●	●	●					
KG9G	●	●	●	●	●	●	●	●	●	●	●	●	●	●					
KG9GX	●	●	●	●	●	●	●	●	●	●	●	●	●	●					
KPGL11A	●	●	●	●	●	●	●	●	●	●	●	●	●	●					
KPGR11A	●	●	●	●	●	●	●	●	●	●	●	●	●	●					
MKT11RG	●	●	●	●	●	●	●	●	●	●	●								
EKT11RGC																			
KGP	●	●	●	●	●	●	●	●	●	●	●								
KGC075	●	●	●	●	●	●	●	●	●	●	●								
EKTF11	●	●	●	●	●	●	●	●	●	●	●								
EKTF11PT/A	●	●	●	●	●	●	●	●	●	●	●	●	●	●					
KT6G																			
KG6X																			
KT21G															●	●	●	●	●
KG21G															●	●	●	●	●



Tecnoeka srl

via Marco Polo, 11 - 35010 Borgoricco, Padova - Italy
Tel. +39.049.5791479 - Tel. +39.049.9300344 - Fax +39.049.5794387

email

info@tecnoeka.com - tecnoekasrl@pec.it

Tecnoeka Iberica S.L.

Cambrils a Reus TV 3141, Km 5,7
43206 Reus (Tarragona)
España
Tel. +34 977 900 198
administracion@tecnoeka.com

Tecnoeka Inc.

3385 Denver Drive
28037 Denver, North Carolina
USA
Tel. +1 704 924-0307
info.usa@tecnoeka.com

Tecnoeka Asia Sdn. Bhd.

No. 32-1, Jalan Puteri 1/2
Bandar Puteri
47100 Puchong
Selangor, Malaysia
Tel. +60 124713100
info.tecnoekaasia@tecnoeka.com

web site

tecnoeka.com

